

TIME COMPACT

Instruction Handbook for:

- ▶ use
- ▶ installation
- ▶ adjustment
- ▶ maintenance



IMPORTANT! Install the gasket included in the documents bag, on the inlet/outlet flange, as shown on page 27.

Table of Content

Safety warnings

Safety warnings symbols legend	4
References to Laws and Norms	4
Personnel in charge of installation	4
Installation, use and maintenance	4
User warnings	5
Important	5
First starting up and Use	5
Installation, first starting up, maintenance and servicing	6
Appliance booklet or central plant booklet	6
Combustion checking	6
Boiler operation and servicing	6

User guide

Keyboard buttons	7
Multi-function display	8
Commands outside the boiler	9
Typical use	10
Preliminary operations	10
Boiler activation	10
Temperature adjustment	10
Anti-Legionella function	11
Hour and day setting	11
Set the display with 4 digits	11
DHW storage management	11
DHW storage forced heating	12
Loading a preset DHW storage program	12
Setting the DHW storage program no. 3 - User	12
INFO menu	13
Holiday menu	14
SPA function	15
Incidental malfunctioning	15
The burner doesn't turn on	15
Shortage of domestic hot water production	15
Boiler inactivity	16
Safety shut off	16
Stand-by mode with anti-frost & anti-locking function	16
"Ambient Anti-Frost" Function	17

Installation

Law and regulation prescriptions for the installer	17
Dimensions and connections	18
Specifications for inlet air	18
Warnings for the installation of optional kits or special systems	18
Floor heating system	18
Pump capacity diagram	19

Domestic water supply characteristics	19
Protection against freezing	19
Moving the boiler	20
Siphon overflow drain	22
Positioning and fastening	22
Hydraulic system (DHW and heating)	23
Advices and suggestions to avoid vibrations and noises in the system	23
Cleaning and preservation of the systems	23
Heating system	24
Condense drain	24
DHW storage tank filling	24
Heating system filling and pressuring	24
Gas connection	25
Electrical connections	26
Flue systems	27
Installation of the flue inlet/outlet flange gasket	27
General indications	27
Dimensioning the inlet and outlet ducts	29
Flue system types	30
Examples of installation of inlet and outlet ducts	31

Adjustment and Maintenance

First starting up	32
Maintenance operations	33
Access to the inside of the boiler	34
Venting the primary exchanger	35
Combustion group cleaning	35
PCB parameters settings (technician menu)	36
Main boiler parameters (PC)	37
Combustion test and adjustment	39
Max heating power adjustment	40
Power input / display / fan rpm tables	41
Electronic settings	41
Accessing the main board	41
Main board settings	41
Gas conversion	42
Draining the system	43
Draining the storage unit	44
Alarms - boiler block	44
Warnings for servicing	50
Technical data	51
Electrical diagram	54
Boiler internal components	56
Hydraulic diagram	57

Addendum

Outdoor Sensor Kit	58
Installation and setting	58
Outdoor Sensor kit and Remote Control	58
Remote Control Kit	59



Safety warnings





This instructions manual is an essential and complementary part of the product and it is supplied together with the boiler.



Carefully read the manual, achieving all important information for a safe installation, use and servicing.

- ▶ **Carefully keep the manual**, together with the documentation of all the accessories of the boiler and of the system, for any further consultation you may need.
- ▶ **The installation** must be carried out by a qualified technician, in accordance with manufacturer instructions and with the relevant requirements of the current issue.
- ▶ **Carbon monoxide (CO) danger:** the CO is a no-smelling and no-colour gas. When a forced draught boiler with air inlet from the room (appliance type B₂) is installed, permanent ventilation of the installation room is mandatory and extremely important. Ventilation must be made and sized in compliance with Laws and Rules in force. Whatever manumission, closing or neutralization of the permanent ventilation could lead to very serious consequences to people in the rooms, as intoxication by CO, permanent damage and death. Besides, the CO and O₂ mix can be explosive.
- ▶ A **qualified technician** is a person with a specific technical competence in the field of the heating appliances for domestic use and domestic hot water production, in compliance with Laws and Rules in force.
- ▶ The **operations that the user can do** are only and exclusively the ones contained in the "USER GUIDE" section.
- ▶ The manufacturer has no contractual and extra-contractual responsibility for any damage arising from wrong installation, wrong use and non-observance of current laws and instructions given by the manufacturer himself.
- ▶ **Important:** this gas boiler is used to heat the water at a temperature lower than the boiling one, at atmospheric pressure; it must be connected to an heating system and/or to a domestic hot water system, in accordance with its features and power.
- ▶ Packing items (cartons, nails, plastic bags and so on) **must not be left within children easy reach**, as they are potentially dangerous.
- ▶ **Before any cleaning or servicing operation**, disconnect the boiler from the mains electrical supply by means of the main electrical switch and stop the gas supply by means of the suitable cock.
- ▶ **In case of fault** and/or bad operation of the appliance, disconnect it immediately and do not try to repair it by yourselves.
- ▶ **Boiler servicing and repair** must be carried out exclusively by qualified technicians, which will use original spare parts. Strictly observe the above requirement, avoiding any risk of compromising the appliance safety.
- ▶ **If the appliance should be definitively dismissed**, remove or cut off any potential dangerous item.
- ▶ **When transferring the appliance** (e.g. leaving it installed after a removal or a sale of the building), make always sure that the instructions manual is close to the boiler for the future use of new owners and/or installers.
- ▶ This appliance **must be used for its clearly recommended utilization only**. Any other utilization must be considered dangerous and incorrect.
- ▶ It is strictly forbidden to use the appliance **for different purposes** than the specified ones.
- ▶ This appliance must be **installed exclusively on the floor**.

Safety warnings symbols legend

 Generic safety warning	 Electrical danger (fulguration)	 Physical danger (personal damage)
 Thermal danger (burns)	 General warning or advice to avoid material damage or to achieve improvements	

References to Laws and Norms

 All the **references to norms and national laws** mentioned in this handbook are indicative as laws and norms are subject to issues and integrations by the authorities in charge. **Also comply to eventual local norms and laws** (not mentioned in this handbook) in force in the territory where the installation takes place.

Personnel in charge of installation

Place here all necessary advices according to national rules about **WORK SAFETY** of Personnel in charge of installation. An example follows:

Law number 192 of 19-August-2005 and further revisions “Title of the law or brief description”.



Always proceed with caution when handling the boiler and carrying out installation/maintenance work as metal parts may cause injuries such as cuts and abrasions. **Wear personal protection devices** (especially gloves) while doing the above mentioned operations

Installation, use and maintenance

Place here all necessary advices according to national rules about **BOILER INSTALLATION**, An example follows.

Law number 412 of 26-July-1993 n°412 and further revisions “Title of the law or brief description”.

User warnings

Important



In case of gas smell:

- 1 - **do not press electrical switches, use the telephone or other objects that can provoke sparks;**
- 2 - **open immediately the windows and the doors in order to cleanse the room air;**
- 3 - **close the gas supply taps;**
- 4 - **call a qualified technician.**



Do not obstruct the ventilation openings of the gas boiler room, in order to avoid possible dangerous situations as the creation of poisonous or explosive mixtures.

First starting up and Use



The first starting up and the maintenance of the boiler must be performed by a professionally qualified staff (for example the installer or the Service Centres authorized by ITALTHERM)

The latter will check that:

- ▶ the label technical data of the gas boiler correspond to those of the gas available;
- ▶ the main burner regulation is compatible with the gas boiler output;
- ▶ the chimney works correctly, expelling the combustion products;
- ▶ the air supply and the combustion products evacuation work correctly, in accordance with the requirements in force;
- ▶ the conditions for a correct ventilation are guaranteed, also when the gas boiler is located inside a closed space (with suitable characteristics).



This boiler is designed and prepared to be supplied with **Natural Gas G20** (Methane) or **Commercial Propane G31**. A qualified technician can convert it to operate with one of these two types of gas above said. It must never be used with **butane gas G30** (that can be present, pure or mixed with Propane G31, in the portable gas bottles for cookers).



The User must not touch sealed items nor break the seals. Only specialized technicians and the official technical service can break the seals of sealed items.



The boiler is fitted with safety devices that block operation the case of problems with the boiler or related systems. These devices must never be disabled: if a device intervenes frequently, have a qualified technician located the cause, even in systems to which the boiler is connected, and in the flue inlet/outlet system that must be efficient and made according to the laws in force (see examples in paragraph "Flue systems" on page 27). If a boiler component has failed, you must only use original replacement parts



When the boiler is off for a long period see the Paragraph "Boiler inactivity" on page 16 for the necessary precautions about the electrical supply, the gas supply and the protection against freezing.



Do not touch the heated surfaces of the boiler, as the doors, the flue, the chimney pipe, etc., also after the boiler operation because, for a certain time, these surfaces are overheated. **Any contact with them can cause dangerous scalds.** It is then forbidden to let children or inexperienced people be close to the boiler, during its operation.

- ▶ Do not expose the wall hung gas boiler to water or other liquids sprinklings, or to vapours directly coming from gas cookers/hobs.
- ▶ Do not obstruct the air inlet or flue outlet terminals, even momentarily or partially.
- ▶ Do not put any object on the gas boiler and don't leave any flammable liquid or solid materials, (e.g. paper, clothes, plastic, polystyrene) in its proximity.
- ▶ This appliance is not intended for use by persons (including children) with reduced physical, sensory or mental capabilities, or lack of experience and knowledge, unless they have been given supervision or instruction concerning use of the appliance by a person responsible for their safety. Children should be supervised to ensure that they do not play with the appliance. *(CEI EN 60335-1:2008-07 § 7.12)*
- ▶ If the gas boiler is going to be definitively unused, call a qualified technician to carry out all required operations, checking in particular disconnection of gas, water and electrical supplies.
- ▶ **Only for those models that draw directly from the installation room** (type B appliances installed in-door): the installation of aspirators, fireplaces or similar appliances in the room where the type B appliance is installed (and in adjacent rooms in case of indirect ventilation) is prohibited except in cases foreseen by rules in force and anyway the installation must be made in compliance with all specific safety measures mentioned in the rules and laws in force, even in case of modifications or additions.

Installation, first starting up, maintenance and servicing

All operations for installation, first starting up, maintenance, servicing and gas conversion **must be carried out by qualified technicians**, in accordance with the Norms and Laws in force.

Maintenance operations must be carried out in compliance with the manufacturer prescriptions, and in compliance with the laws and rules presently in force for what is not mentioned in this handbook; we advice to perform them at least once a year to maintain the boiler's performance.

Appliance booklet or central plant booklet

All appliances must have an appliance booklet (for outputs less or equal 35 kW) or a central plant booklet (for outputs more than 35 kW). All maintenance and servicing operations and combustion checks must be written on the booklet, together with the name of the person responsible for servicing.

Combustion checking

Combustion checking consists of a control of the boiler efficiency. Boilers that, after the checking, will have efficiency rates lower than the ones required and not changeable with suitable adjustments (that must be performed by qualified technicians), must be replaced.

Boiler operation and servicing

The user (owner or tenant of the flat where the boiler is installed) or the administrator of the block of flats (in case of a central heating system) are responsible for the appliance operation and servicing; they can both transfer the responsibility of the servicing and eventually of the operation to another person, which must be a qualified technician as indicated by the Laws. Even if the user or the administrator decide to assume personally this responsibility, ordinary servicing of the warm air heater and combustion checks must be anyway carried out by a qualified technician



Keyboard buttons

Note: the here below keyboard features are referred to the standard way of working. When accessories are installed, a few special settings are in progress or, in case of being in the technician Menu, buttons may perform differently.



Stand -by/Way of functioning

At every press, the boiler switches its mode from OFF to summer or winter or heating-only mode.



CH setting

To set the CH system temperature. If the Outdoor Sensor Kit was installed, see also "Outdoor Sensor Kit" on page 58.



DHW setting

To set the DHW temperature in the storage.

INFO

It displays all the additional boiler information. For deeper details go to "INFO menu" on page 13.

RESET

Press to reset the boiler in case of breakdown.

See "Alarms - boiler block" on page 44.

plus

It manually sets the activation and inactivation of the DHW storage forced heating.



It sets the hourly setting of the DHW storage program. It's used also during the programming of the DHW storage program itself and for the setting of the clock.

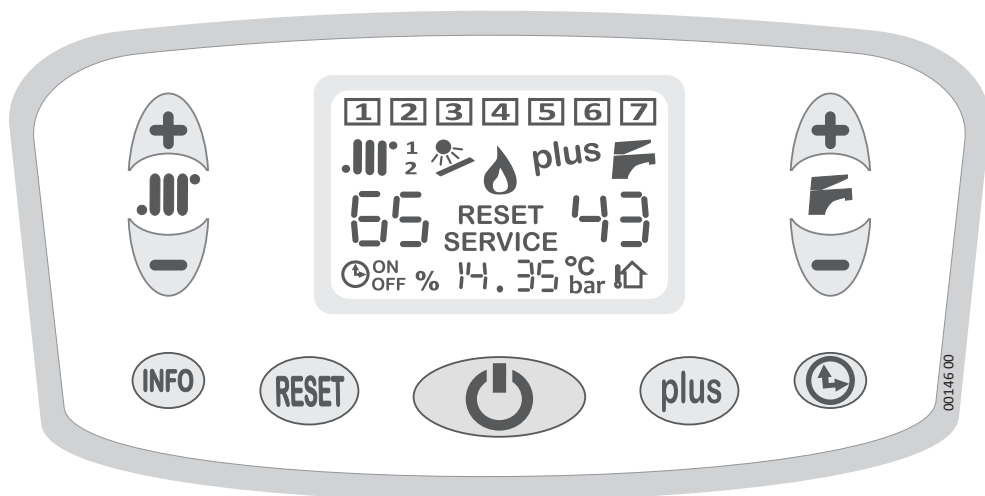

Multi-function display

	<p>Weekly day</p> <p>Shown during the CH setting program. Otherwise, days are showed on the display if the reference function (to make them displayed) is activated.</p>	
	<p>CH – winter mode</p> <p>If flashing, it means that the boiler is functioning in CH mode.</p>	
<p>1 2</p>	<p>CH zone require</p> <p>It shows which CH zone is demanding for heating.</p>	
	<p>DHW time slot indication</p> <p>During the DHW program setting (see "Setting the DHW storage program no. 3 - User" on page 12) it shows which time slot, among the two available, you are programming.</p>	
	<p>Solar system detected (if connected to the boiler through the optional Solar PCB)</p> <p>When the boiler is providing heating to the solar storage, the symbol blinks.</p>	
	<p>Burner ON</p>	
<p>plus</p>	<p>DHW storage quick heating</p> <p>It indicates that the DHW storage <i>quick</i> heating function is ON. It flashes when the boiler is working for that.</p>	
	<p>DHW storage heating</p> <p>It indicates that the DHW storage heating is enabled. It flashes to inform that the heating of the DHW storage is in process.</p>	
<p>65</p>	<p>CH temperature, in °C (two digits under the symbol .III)</p> <p>It usually shows the CH flow temperature.</p>	
	<p>During the CH temperature setting (by pressing the buttons + .III and - .III), it shows the temperature value changing.</p>	
<p>RESET or</p>	<p>Appears when the boiler is lock (SERVICE or RESET kind of error). See "Alarms - boiler block" on page 44 to understand how to manage.</p>	
<p>SERVICE</p>		
<p>43</p>	<p>DHW temperature, in °C (two digits under the symbol fan)</p> <p>It shows the DHW temperature set value.</p>	

00147 A 00



It shows the DHW storage heating is ON in scheduled mode.

ON
OFF

It shows, in combination with the symbol , when the DHW storage heating mode is **ON** or **OFF**.

%

It appears when the two digits at its right are showing the burner power during the functioning. This information is just available by entering the **INFO** menu (see "INFO menu" on page 13).

14.35

These four digits (in the middle of the display) show a few information even during the standard boiler functioning: current clock time, CH water pressure, outdoor probe temperature (in case the outdoor probe  is installed). Thanks to the menu **INFO**, others information are available to be displayed. It is even possible to choose the data normally displayed by using the menu (see "Set the display with 4 digits" on page 11; or "INFO menu" on page 13 for other information).

When the boiler is powered but in **OFF** mode anyway, this indicator shows **OFF**.

°C
bar

They show the unit of measure of the data (shown on the left). If they are switched off, the data may mean the clock time or whatever data different than Bar or °C.



It informs that the outdoor probe (accessories) is installed.

Note: In this case the CH system temperature is automatically set and so the use of buttons **+ .III** and **- .III** is different from the standard way: for deeper details rely on kit instruction and see "Outdoor Sensor Kit" on page 58.

Commands outside the boiler

Externally the boiler, located near to it or suitably positioned in the building (generally by the installer or by the electrician), two devices that the user should access to, are present. The presence and the characteristics of these devices are prescribed by the regulation in force.

Gas cock: It is located near to the back side of the boiler, along the gas connection pipe. It should be opened to allow the gas supply to the boiler and it should be closed any time it's requested to close the gas supply, e.g. when long inactivity periods are foreseen (see "Safety shut off" on page 16) or in any emergency case (see "Important" on page 5).

ON/OFF switch: usually it is installed close to the boiler in order to isolate the boiler from the rest of the whole electrical power system supply.

Room thermostat: it commands electrically the boiler to activate or deactivate the heating system, in order to keep the room temperature (detected by a sensor) within a value set by the user, Regulation in force prescribe its positioning, the temperature limits within the user can adjust it and the periods of heating.















Note: *ITALTHERM offers (as accessory) a vanguard room thermostat, with weekly set having many levels of temperatures available to be set and other ahead functions. Moreover available, there are two version of this device in GSM and wireless way of functioning.*

Typical use

Preliminary operations

- ▶ Be sure the gas cock is opened.
- ▶ Be sure the boiler is electrically powered and set in **OFF**: only **OFF** has to be displayed on the screen.

Boiler activation















- ▶ Press the button :
 - once to set the boiler in summer mode only (DHW only). Summer mode is recognizable by the only symbol presence  on the display and not by the symbol presence ;
 - pressing twice to set the boiler in winter mode for making the boiler working both for CH and DHW. Winter mode is recognizable by the both symbols presence  and  on the display;
 - press it one time further to set the boiler in Central Heating-only mode, which means to disable the DHW storage heating (only the relevant anti-freeze function remains active). The CH-only mode is recognizable by the only symbol presence  on the display and not by the symbol presence ;
 - at each press of the button , the boiler cyclically switches from **OFF** to Summer  to winter  +  and to CH-only  mode.
- ▶ On winter mode  + , when room thermostat demands for heating, the burner fires up and thanks to the water flow the heating get transferred. In case of contemporary demand of both DHW storage heating and CH, the DHW demand has the priority till the storage gets heated. Usually, as DHW storage heating does not last for long, this priority does not affect the CH efficiency in the system.

Temperature adjustment

Note: correct adjustment leads to creating the conditions for energy saving.

Note: if a Low Temperature Kit or an Outdoor Probe Kit are installed, refer to the relevant documentation for what concerns the heating system temperature adjustment.

Note: don't make confusion between the heating system temperature  here described, with the temperature of the room set on the Room Thermostat.

- ▶ **Heating system adjustment:** by using the buttons   and  , the setting of the heating system temperature is made (the value, during the adjustment, is shown on the display under the symbol ). Generally, in the deep cold season and/or with poor building thermal insulation (or if you notice that the burner stays on for a long time, but the room temperature rises too slowly) prefer higher settings. On the contrary, if you notice that the room temperature exceeds too much, for thermal inertia, the value set on the room temperature, it's appropriate to decrease the system temperature. **When the optional Outdoor Temperature Probe Kit is installed, the system temperature is automatically managed and the use of the buttons   and   is different: for details, see also "Outdoor Sensor Kit" on page 58.**
- ▶ **Domestic hot water adjustment:** the buttons   and   set the temperature of the hot water inside the storage (the set value is shown on the display under the symbol ). On this type of boiler, we suggest to set it in such a way to have a comfortable hot water temperature by drawing only hot water or eventually by mixing it with a little cold water. **Avoid maximum values** if not strictly needed, that will force to mix the hot water with bigger quantities of cold water.

Anti-Legionella function











With regular periodicity the boiler, in Summer or Winter mode, automatically provides for the heating of the water in the storage, so as to destroy eventual bacteria (especially *Legionella spp.*) which form in quiet warm water.

Remark: the Anti-Legionella function is not active when the boiler is set in **OFF** or in **CH-only** mode. 

Hour and day setting

Note: after 20 seconds without pressing any button, the function quits without saving.

Daily and hourly set are strictly necessary in case weekly program and holiday menu is desired.

- ▶ press for at least 5 seconds the button  with the boiler in OFF mode;
- ▶ the clock hours will be flashing, thanks to buttons  and  is possible to set the hour time;
- ▶ press the button  and the minutes digit will be flashing. Therefore, adjust the minutes by using the buttons  and ;
- ▶ press the button  and the weekly day  ...  will be flashing. Therefore, adjust the days by using the buttons  and .

Note: for instance, in order to set Monday like first weekly day number 1 (set number 3 in case today was Wednesday).

- ▶ Store the setting and exit the mode by pressing ; for at least 5 seconds.

Set the display with 4 digits

During the standard function the four digits take place in the bottom side of the screen and can show:

- No indication (choose this if you don't want any indication)
- No indication (data not available in this model, so the function isn't supported)
- Current time (if the clock hasn't been set yet: no indication)
- CH water pressure
- Outdoor probe temperature (if it is installed - in this case the symbol  is shown, otherwise "-- °C" is displayed)

To choose what data has to be displayed:

- ▶ with the boiler in winter or summer mode (no OFF mode), press the button **INFO** one or more times to toggle among the display modes.

DHW storage management

Note: if the clock has not been set yet (see "Hour and day setting" on page 11) any functions that foresee automatic DHW storage scheduling cannot be set.

DHW storage forced heating

By pressing the button **plus** you can activate immediately the DHW storage heating cycle (and/or speed it up, depending on the case). This function is automatically deactivated at the end of the cycle.

- ▶ if the storage was active for a short time (even in standard or scheduled mode) the function speeds up the storage heating (the symbol **plus** blinks) and ends when the storage reaches the temperature;
- ▶ if the storage was in scheduled mode and now it was in an inactive time slot (symbol **OFF**) a quick heating cycle is started (symbol **plus** blinking) then the storage is kept in temperature (symbol **plus** on) up to the end of the same time slot. On the further active time slot, the program returns to the normal schedule. The DHW schedule doesn't get modified.
- ▶ To manually deactivate the cycle, press the button **plus** (the symbol **plus** turns off).

Loading a preset DHW storage program

Note: after 20 seconds without pressing any button, the function quits without saving.

It is possible to load a DHW storage program among the three available: two are factory-preset and permanently stored in the boiler's memory; the third program can be personalized by yourself as described further on.

Program 1: ON MON÷FRI 06:00÷09:00 and 17:00÷21:00; SAT÷SUN 06:00÷10:00 and 16:00÷21:00

Program 2: ON all days 06:00÷10:00 and 16:00÷21:00

Program 3: user-customizable program (on a new boiler, it's factory set same as program 1).

- ▶ The boiler must be set in winter or summer mode (no OFF or heating-only mode), and press the button **↻** for at least 5 seconds: the display shows the current program number (P1, P2, P3), on the right;
- ▶ choose the suitable program by buttons **+F** and **-F** and press **↻** to load it;
 - choosing **P3** (custom program) the relevant data appear on the display: now it's possible to edit it as described in "Setting the DHW storage program no. 3 - User" on page 12 or you can simply load it as it is by pressing **↻** for at least 5 seconds;
- ▶ at this point, the boiler switches back to winter or summer mode. To make the DHW storage heating scheduled, press **↻**: on the display should be visible the symbol **ON** (or **OFF** depending on the state of the current time slot).

Setting the DHW storage program no. 3 - User

Note: after 2 minutes without pressing any button, the function quits without saving.

1. Determine one or two time slot, for every day of the week, in which the hot water is thought to be required. Daily and hourly set can both be the same or different day by day.
2. set the boiler in winter or in summer mode (no OFF or heating-only mode) and press the button **↻** for at least 5 seconds;
3. choose the program **P3** using **+F** and **-F** and press **↻** to load it;
4. the display shows the current day (e.g. the day **1**), a little number "**1**" on the upper-left part, the symbol **ON** and a time, meaning that currently the **activation** of DHW heating, on the **first time slot** of the **first day**, is scheduled on that time;
5. press the button **↻** for entering in the timer setting, that starts blinking;

6. use the buttons **+F** and **-F** for modifying the **starting time** of the **first time slot** of DHW heating activation (10 minutes steps), and then press **+...|||** ;

Note: timings are stored exclusively by pressing the button **+...|||** . Besides, this will position the programming on the following event.

7. the symbol **⌚OFF** as well as another time appears, which means that the first **deactivation** is set on that time;
8. press **⌚** (the time blinks); use the buttons **+F** and **-F** for modifying the **ending time** of the **first time slot** of Acqua Step activation (10 minutes steps), and then press **+...|||** ;
9. the display now shows a little number "2" on the upper-left part, the symbol **⌚ON** and a time, meaning that you are programming the **second time slot** of the DHW heating function, of the same day. Proceed in the same way as you just did for the first time slot;
10. after the last press of the button **+...|||** the day 2 is selected and you can set it as described for the day 1; otherwise you can **copy** the day 1 schedule on the day 2 as follows:
- return to day 1, already programmed, using the button **-...|||** . Then, press the button **INFO** for 5 seconds: the symbol of the day 2 will be flashing;
 - press **⌚** to confirm the copy of the day 1 on the day 2 and skip to this latter;
 - similarly, to copy the program to the further day 3 after (and so on), it's sufficient to press the button **INFO** for 5 seconds, and press **⌚** to confirm the copy.
11. press the button **⌚** for at least 5 seconds to exit and return in winter or summer mode as at the beginning.

+... 	TIME SLOT or DAY
-... 	forward - backward
+F	TIME
-F	increase - decrease

INFO menu

It is possible to get a few information displayed on the screen as far as regards the boiler functioning which can be showed on some different screen pages. Usually they are useful for the Technician only. Anyway, even the user can look at them without affecting the good working of the boiler.

- ▶ With the boiler in winter or summer mode (no OFF mode), press the button **INFO** for at least 5 seconds;
- ▶ the display will show the **page 1** (information about the **current work** in progress):
 - **1** ... **7** : boiler cycle in progress (technician reserved information)
 - **.|||** heating mode ON, **F** DHW ON: shown symbol = available function; if flashing, the mode is in progress; **1** activated zone(s), **☀** solar system
 - **🔥** = Burner ON
 - indicator number **1**: CH system flow temperature in °C
 - indicator number **2**: DHW temperature in °C
 - indicator number **3**: burner power in % from 0 to 99 (0 = minimum)
 - indicator number **4**: CH system return temperature in °C

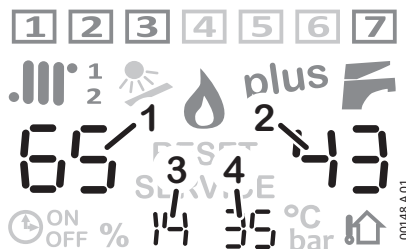

- ▶ press the button **+ .III** : to get to the **page 2** (information about the **boiler settings**):

- **.III** heating, **F** DHW: they support the numeric indications;
- indicator number **1**: Primary CH flow temperature set value, or, if outdoor probe **🏠** is installed, ignore this value;
- indicator number **2**: DHW temperature (set temperature)
- indicator number **3**: Secondary CH flow (set temperature)

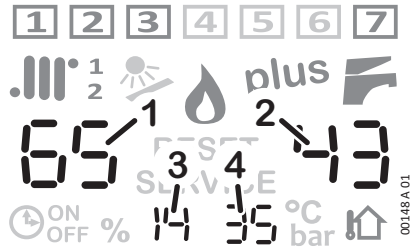

- ▶ Press the button **+ .III** : the display shows the **page 3** : information which are referred to the **thermoregulation** (if the outdoor probe **🏠** is installed only).
 - **.III** CH system, **1/2** zone/s, **🏠** outdoor probe: they support the numeric indications.
 - indicator number **1**: CH flow temperature to the primary zone (shown when the request is on). The temperature is calculated on the base on the outdoor probe temperature according to its **kd** curve setting
 - indicator number **2**: outdoor probe **kd** curve number
 - indicator number **3**: CH flow temperature to the secondary zone (shown when the request is on). The temperature is calculated on the base on the outdoor probe temperature according to its **kd** curve setting
 - indicator number **4**: Outdoor temperature felt by the outdoor probe. If the value is **-9** it means that the outdoor temperature is **9° C** below **0°** or even lower.
- ▶ Pressing the buttons **+ .III** and **- .III** it is possible to turn the pages onward or backward;
- ▶ Press the button **INFO** to exit the INFO menu. Anyway, after 15 minutes the boiler automatically exits the menu.

Holiday menu

Note: if the clock has not been set yet (see "Hour and day setting" on page 11) this function cannot be used.

The user can decide to keep the boiler on OFF mode as many days as he wants. After that, the boiler automatically returns in winter mode (or, if the optional Remote Control is installed, this latter returns in the mode it was in the moment of the activation, while the boiler returns in Summer mode to allow the correct work of the Remote Control).



- ▶ The boiler must be set on OFF mode (not in winter or summer mode), and press the button **🔌** for at least 5 seconds;
- ▶ on the left side of the display the symbol **🕒** and "Ho" will appear as well as on the right side a value number;
- ▶ press the buttons **+ F** and **- F** to set the number of inactivity days (don't include the current day);
- ▶ press the button **🔌** for at least 3 second to save the setting. From now the Holiday function is ON and will expire at 23:59:59 of the last day.

Note: afterwards, it is possible to set the boiler in modes different from OFF, **but the Holiday function will operate only if the boiler is set to OFF.**

SPA function

Note: if the optional Remote Control is installed, this function can only be managed by it.

This function is useful, in example, when a bath tub has to be filled. It forces the DHW temperature to the maximum for **60** minutes, then the function deactivates automatically.

- ▶ With the boiler in winter or summer mode (no OFF mode), press the button **plus** for at least 5 seconds;
- ▶ on the central, lower side of the display, the indication "SPA" appears, and the digits below the symbol  blink;
- ▶ to deactivate the function before, press one of the buttons **+ ** or **- **.

Incidental malfunctioning





Avoid performing personally any intervention that are job of the technician, for example the ones on the electrical circuits, on hydraulic system or on the gas system, and whatever other operation that's not mentioned in this "User Guide" section and expressly allowed to the User. Always address yourselves to qualified personnel.

Boilers must be always equipped with original accessories only.

ITALTHERM Srl is not responsible for damages caused by the incorrect, wrong or unreasonable use of not original materials.

The burner doesn't turn on

- ▶ if the room thermostat (or programmable room thermostat, or similar) is installed, check that it is really requiring the room heating;
- ▶ Be sure the boiler is set on winter **.III** +  or summer  mode (not in **OFF**). The reference symbols must be shown on the display (see "Multi-function display" on page 8);
- ▶ In case the display shows **RESET** or **SERVICE** , or in case the boiler seems to be working in an inappropriate way, see "Alarms - boiler block" on page 44;
- ▶ check the CH pressure is correct (1÷1.5 Bar **in a cold state**) or anyway **not lower than 0.5 Bar**;

Shortage of domestic hot water production

- ▶ check the DHW temperature is not set on a too low value: if so, adjust it (see "Temperature adjustment" on page 10);
- ▶ call a qualified technician to check gas valve regulation;
- ▶ call a qualified technician to check, and eventually clean, the coil of the DHW storage.



Remark: where the water hardness value is too high, it is suggested the installation of a softening device, in order to prevent the limestone precipitation; this operation avoids a frequent cleaning of the coil of the DHW storage.

Boiler inactivity

The effects of the periods of inactivity can be relevant in particular situations such as in flats used only for some months per year, most of all in cold places.

The user will have to decide to put the boiler in the **SAFETY SHUT OFF state** disconnecting all the supplies, or to **leave it on OFF mode (but electrically supplied) in order to let the Anti Frost Function work**. When there is the possibility of freezing it is convenient to choose between the advantages and the disadvantages of the SAFETY SHUT OFF and of the Stand By/Anti Freezing Way.

Safety shut off

- ▶ Turn off the general switch on the Electrical Supply Line of the Boiler;
- ▶ Close the Gas Tap;

(i) When it is expected that the temperature is going to decrease under 0°C, call a technician to do the following:

- Fill the system, included the primary circuit of the storage unit and the relevant coil, with an anti-freezing solution (unless the system was already filled with said solution) otherwise it must be completely emptied. Notice that if it had been necessary to restore the pressure (because of possible loss) in an heating system already filled with an Anti freezing solution, the concentration of the solution could have decreased and it could not guarantee the Anti freezing Protection.
- Let the condense collector syphon be emptied unscrewing its inferior cap.
- completely empty the hot and cold sanitary water system, including the sanitary circuit and the boiler's DHW storage.

Remark: *the boiler is equipped with a system which protects the main components from the exceptional cases of mechanical lock, due to the inactivity in presence of water and scale. The anti-locking function can't work in Safety shut off mode, because of the lack of electrical supply.*

(i) Before re-igniting the boiler, have a technician check that the pump is not blocked due to inactivity (for the technician: unscrew the plug in the centre of the cap to access the rotor shaft and turn it with a screwdriver or other suitable tool).

Stand-by mode with anti-frost & anti-locking function

When the boiler is left in **OFF** mode during a period of inactivity, it will be protected against freezing by several functions provided in the electronic controller, which heat the parts involved when the temperature falls below factory set values.

The anti-frost heating is accomplished by turning on the burner and pump.

In addition, when the boiler is in stand-by, it periodically activates the main internal components to avoid rare cases of blockage due to inactivity in the presence of water and lime. This can also occur when the boiler is locked (red lamp on) provided that the system pressure is correct.

In order for these systems to be active:

- the boiler must be receiving gas and electricity;
- boiler must be left on **OFF** mode (OFF shown on the display);
- system pressure must be correct (1÷1.5 bar in a cold state, minimum 0.5 bar)

In case of lack of gas, the burner won't turn on and the boiler will go in LOCK OUT state (red lamp on or flashing). Nevertheless the pump will work, making the water circulate in the system and reducing in this way the possibility of freezing.



(i) ATTENTION: the anti-frost protections cannot intervene in the absence of electricity. If you anticipate this possibility, we recommend you add a good brand of anti-freeze to the heating system, following the producer's instructions.

We recommend to ask directly the installer/technician about the type of antifreeze product put in the heating system during installation.

When the power comes back on, the boiler will check the temperature measured by the two probes and, if it suspects freezing verified by a particular automatic control cycle, alarm 39 will be triggered. For more details, see the relative description in the paragraph "Alarms - boiler block" on page 44.

(i) We recommend that you completely empty the hot and cold sanitary water system. The anti-frost function does not protect the sanitary circuit outside the boiler.

"Ambient Anti-Frost" Function

Note: if you want to use the "Ambient Anti-Frost" function that is often available in common room thermostats or chronothermostats, it is necessary to leave the boiler on Winter  +  mode and NOT on OFF mode.

(i) The "Ambient Anti-Frost" function does not protect the sanitary circuit outside the boiler and, especially, in areas where the heating system doesn't reach. For this reason, we recommend that you empty the cold and hot sanitary system, if they were at risk of freezing.



Installation

Law and regulation prescriptions for the installer

Note for the translator/writer: Place in this paragraph all the recommendations relevant to the compliance with laws in the destination nation/country (if any). As an example (from Italian regulation):

Characteristics of the room: as this boiler has an heat output lower than 35 kW (about 30000 Kcal/h), it is not required to install the appliance in a dedicated room, provided that the room complies with the regulation in force and that all installation rules assuring a safe and regular gas boiler operation, are strictly respected.



Permanent ventilation of the installation room is mandatory and extremely important when a boiler with air draught from the installation room (B... appliance type) is installed. Ventilation must be made and sized in compliance with Laws and Rules in force.

Instructing the user: at the end of the installation, the installer must:

- explain the operation of the boiler and its safety devices to the user;
- give this user this booklet and the documentation within his/her competence, duly filled in where required.

Dimensions and connections

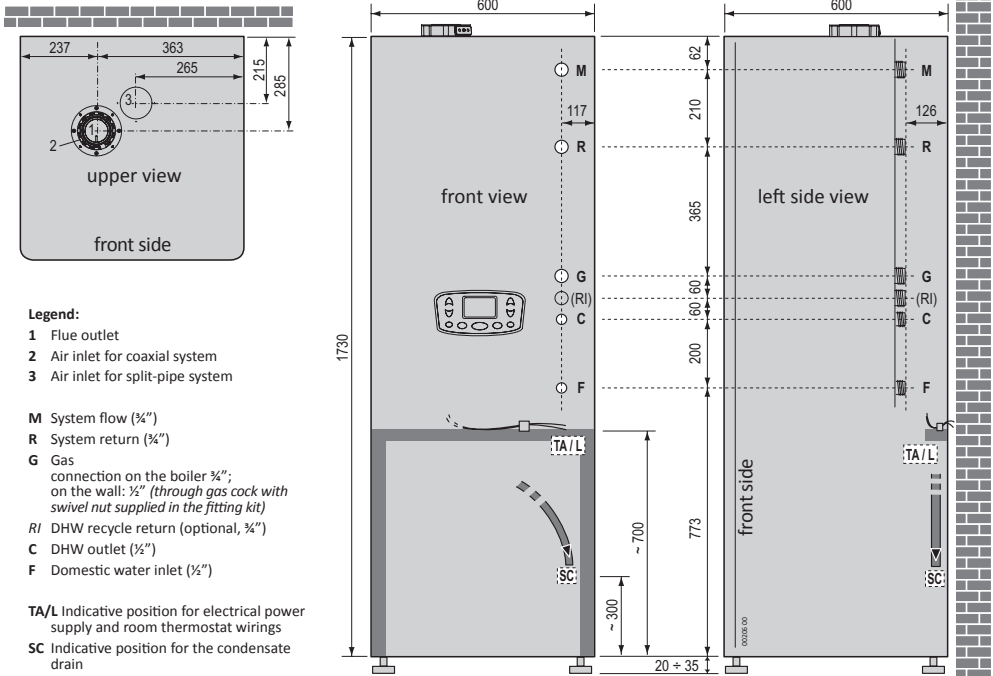

Specifications for inlet air

Air must be withdrawn from places free of pollutant (like fluorine, chlorine, sulfur, ammonia, alkaline or similar agents). In the event of installation of the boiler in atmospheres with not negligible presence of aggressive chemical substances (e.g. hairdressing salons, laundries) we recommend to foresee the air inlet from outdoor, choosing the type C installation.

Warnings for the installation of optional kits or special systems

Floor heating system

(i) The safety thermostat(s) that protects the floor against overheating (that could damage the cladding, the structure or the system itself) must be installed on the flow starting end of the serpentine embedded in the floor itself. It should not be installed on the system flow pipe in proximity of the boiler, otherwise frequent and unjustified boiler locks, caused by its triggering, are possible.

Pump capacity diagram

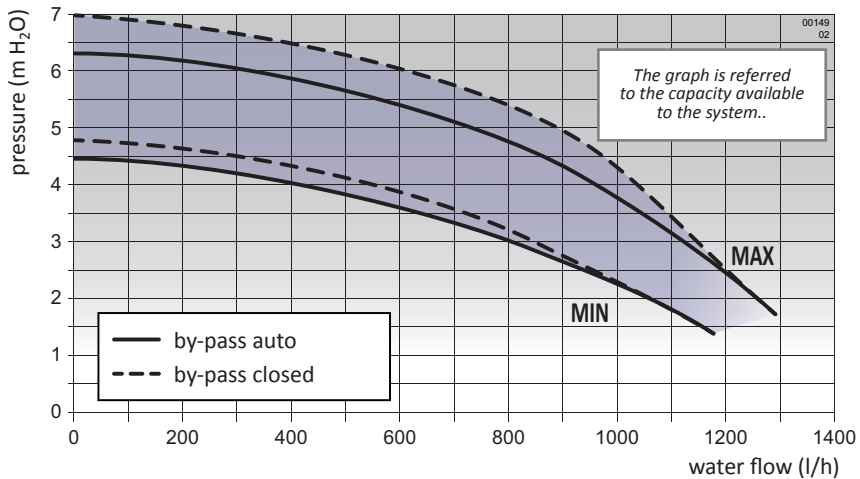

Note: the diagram MAX is referred to the maximum working power of the pump, the diagram MIN depends on electronics. The pump is continuous electronic modulation type and therefore it can work on any point between them.

Domestic water supply characteristics

The cold water inlet pressure should be within the minimum and maximum limits specified in "Technical data" on page 51. The minimum pressure limit is foreseen to allow the correct restore of the pressure in the heating system.

(i) In case of water pressure above the maximum limit, it is indispensable to install a **PRESSURE REDUCER** upstream the boiler.

The cleaning frequency of the storage coil depends on the water supply hardness. If the water hardness is more than 25° fr it's required to install a softener to bring the hardness below that value.

Besides, the presence of solid residuals or impurities in the water (for example in case of new systems) could compromise the correct functioning of the boiler. For DHW production systems, the regulation in force prescribes a safety filter to protect the systems.

(i) The condensing burner/exchanger assembly requires **particular characteristics for the heating system liquid**, more restrictive than the ones of the inlet domestic water. See the "Heating" section of the table "Technical data" on page 51.

Protection against freezing

Thanks to its antifreeze system, inner components could never reach a temperature lower than 5°C. This system is activated when the boiler is supplied by the electrical and gas lines, provided that the pressure in the heating system is correct.

(i) In case of boiler installation in rooms where temperature can drop down to 0°, it is advisable to fill the heating circuit (included the primary circuit of the storage unit and the relevant coil) with an antifreeze liquid specific for heating systems, propylenic glycol based, following the in-

structions of its manufacturer. Pay attention to the correct product concentration: adding those substances to the heating water in incorrect dose could lead to the deformation of the seals and cause unusual noises during operation.

ITALTHERM S.r.l. will not be held responsible for consequent damages.

Instruct the User about the antifreeze function of the boiler and about the antifreeze product added in the heating system.

Moving the boiler

(i) The boiler could be damaged if the precautions here described are not respected.

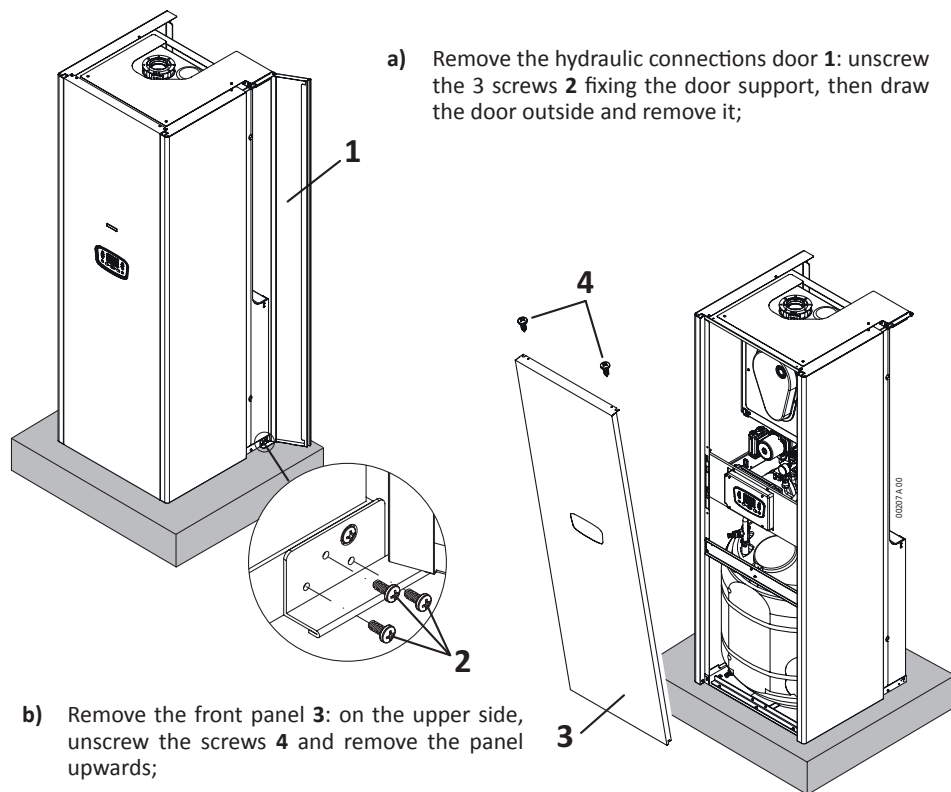

- c) Remove the side panels: on the boiler's upper side, unscrew the screws 5 and remove the panel 6 upwards, then unscrew the screws 7 and remove the panel 8 upwards;

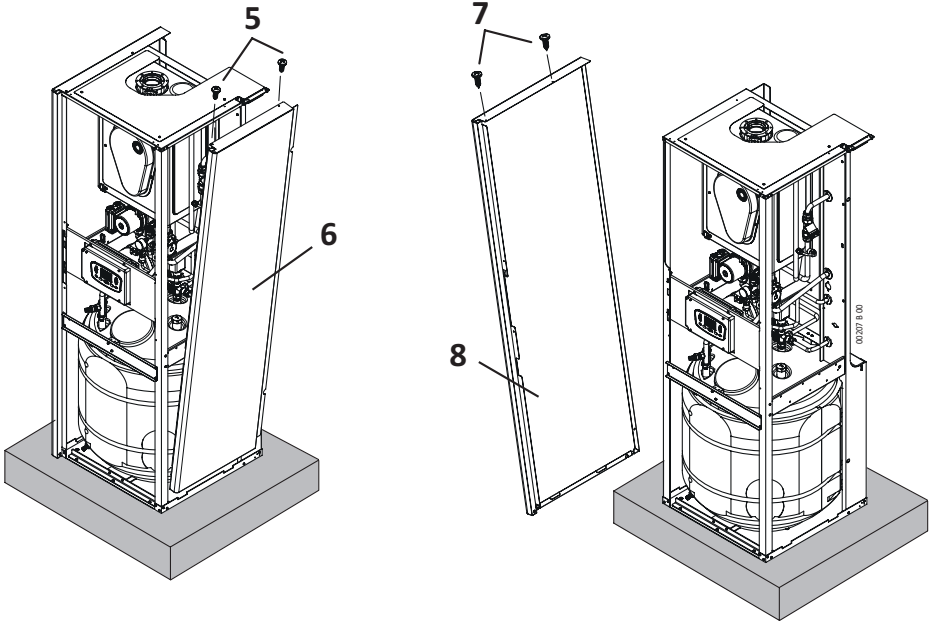

- d) Remove the boiler from the pallet and screw the adjustable screw pads 9 in the positions shown in picture;
- e) Place the boiler on the floor and install the panels by carrying out backwards the previous operations.

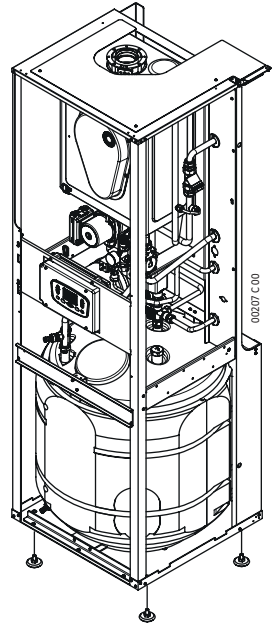
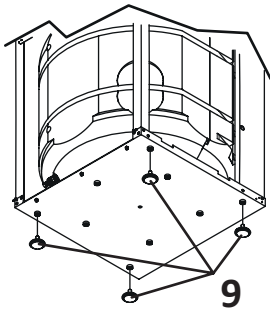

Siphon overflow drain

The boiler's siphon is equipped with a supplementary safety discharge **SCD** that protects the burner in the very situation in which the condensate does not flow correctly from the drain pipe downstream from the siphon. Since this is easily accessible from the rear of the boiler, evaluate the opportunity to use it or not **before** installing the boiler, by connecting to it a section of flexible hose **1** suitable for condensate. On its other end, the hose **1** should be inserted, avoiding bends and kinks, in a suitable drain, such as the funnel of the condensate drain or safety valve. Do not pierce the prepared hole **4**.

As an alternative, although **NOT** recommended, you could simply leave the drain **SCD** open. The burner will anyway be protected if the siphon gets accidentally blocked, but the condensate (acid) will leak into the environment and could damage surfaces it touches (such as marble).



Check the seal of siphon, making sure that the caps **2, 3, 5 and 6** are properly and completely screwed/inserted.



Positioning and fastening

Remark: A re-usable metal jig (**D** in the figure) can be ordered separately, so as to facilitate connections and fixing points positioning (when the original connection kit is used). **If the metal jig and/or the original connection kit are not used, refer to the paragraph "Dimensions and connections" on page 18 for the position of the connections directly on the boiler.**

- ▶ Locate the exact position of the boiler considering the sufficient clearances for maintenance and servicing, especially 280mm on the right side to allow the opening of the connection door.
- ▶ If the metal jig is used, fix it on the wall caring to position the upper side at 1750mm...1765mm from the floor (boiler's support pads can be adjusted within these limits *). Holes **B** can be eventually used to fix the jig by means of screw anchors.
- ▶ Fix up the connections and all ducts for heating flow and return, storage coil flow and return, cold water, gas and electrical cables, predisposing them in the holes of the metal jig or respecting the measures in the paragraph "Dimensions and connections" on page 18.
- ▶ Remove the jig.

(i) Remove, from the boiler, all the plastic caps placed to close the hydraulic connections.

- ▶ Proceed with the hydraulic, gas, electrical and flue connections following the instructions and warnings reported in the following paragraphs.

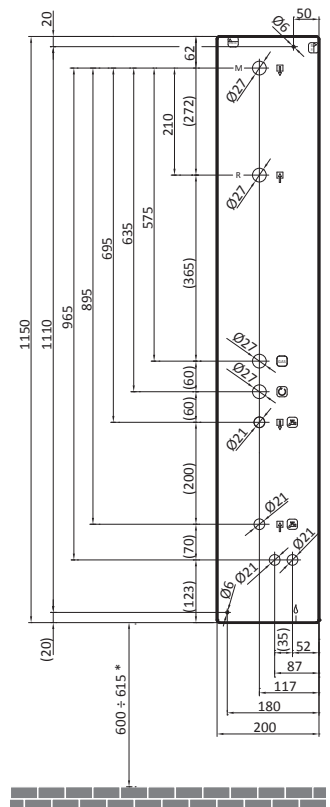
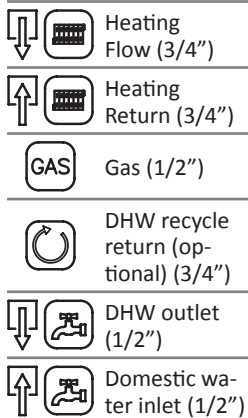

(i) The connections of the boiler are engineered to fit plain couplings with screw ring, interposing a plain gasket of suitable size and material, that ensure a reliable seal even without excessive tightening force. They are NOT suitable for hemp, teflon tape or similar materials

Remark: *the lower grid is spare inside packing, not assembled. We suggest to fix the grid only at the end of the boiler installation operations.*

- ▶ For air inlet and flue outlet ducts connection, please refer to "Flue systems" on page 27, where measures are referred to the upper edge of boiler's body.

Hydraulic system (DHW and heating)



Make sure that the hydraulic and heating systems ducts **are not used as earth connections of the electrical system**. They are absolutely NOT SUITABLE for such a use. Besides: they don't guarantee the earth dispersion; in case of electrical fault they could generate a fulguration risk; there could take place galvanic currents in the pipings and consequent corrosion and hydraulic leaks.

Advices and suggestions to avoid vibrations and noises in the system

- ▶ Do not use pipes with reduced diameters;
- ▶ Do not use bends with small radius and reductions of important sections.

Cleaning and preservation of the systems

The efficiency, the reliability and the safety of the boilers, as all generic thermal systems and components, depend strictly on the features of the water that supply them and on their treatment.

A proper treatment of the water improves the protection of the systems against corrosions (and therefore perforations, noise, leaks, etc.) and limestone incrustations that drastically reduce the efficiency of the thermal exchange (consider that 1 mm of limestone incrustations reduces of 18% the thermal exchange of the heating element on which it has been formed).

ITALTHERM guarantees its products only if the characteristics of the water comply with UNI 8065, reported also in laws on energy saving.

(i) Thoroughly wash the heating system with water, before connecting the boiler. This will eliminate residual like welding drops, slag, hemp, mastic, mud, rust and other dirt from pipes and radiators. Otherwise, these substances could enter the boiler and damage the internal components (pump etc.).

- ▶ **In case of old or very dirty systems, to wash them use specific, proven efficiency products**, in the suitable quantity and following the instructions of its manufacturer.
- ▶ If the water on boiler inlet is harder than 25° fr, it's required to install a softener to bring the hardness below that value, as required by the reference regulation.
- ▶ For floor system and generally all low temperature systems, the water treatment product must have filming action (protection against corrosion and incrustation) and action against bacteria and algae.

Heating system

- ▶ Connect the safety evacuation ducts of the boiler to an evacuation funnel. If safety valves are not connected to an evacuation device, their intervention could flood the room. The manufacturer cannot be held responsible for any damage arising from that situation.

Condense drain

Insert the flexible pipe of condense outlet inside the outlet funnel (or other inspectable connection device) properly installed for this purpose, or in the outlet funnel of the safety valve, in case of the above mentioned outlet is able to receive the acid liquids of the condense as foreseen by the norms in force in matter of condensing boilers.

- (i)** The system must be made in order to avoid the condense freezing. Before the activation of the appliance be sure that the condense can be evacuated correctly.

DHW storage tank filling

- ▶ Adjust the pressure of the DHW expansion vessel (see "Boiler internal components" on page 56) to the same pressure of the aqueduct;
- ▶ open one of the hot water taps in the DHW system;
- ▶ gradually open the hand valve installed on the cold water inlet of the storage unit;
- ▶ when only water flows out of the tap, close it.

Heating system filling and pressuring

Once all system connections have been carried out, and after having filled the DHW storage tank, proceed with system filling. This operation should be made with care, respecting the following steps:

- (i)** During this operation, the boiler should NOT be electrically supplied.
If the boiler is supplied, an automatic system filling cycle will start. If the system is empty, this operation will be incorrectly performed and it will cause, uselessly, many boiler blocks.

- ▶ Open the radiators venting devices;
- ▶ Check that the plug of the automatic air vent, incorporated in the boiler circulator, is unscrewed: if not, unscrew it and leave it unscrewed, even afterwards, for normal operation;
- ▶ If it's required to fill the system with anti-freeze solution, do this operation, then hermetically close the connection or the valve used to put the solution in, to allow the pressurization.
- ▶ Slowly turn the screw **1** on the filling electrovalve, from position "C" to position "A" (see picture);
- ▶ Check the correct functioning of automatic venting devices, eventually installed on the heating system and/or on the storage coil circuit;
- ▶ Close the radiators venting devices as soon as water flows out of them;
- ▶ If the storage coil or the relevant circuit were equipped with manual venting valves, use them to purge the residual air from them;

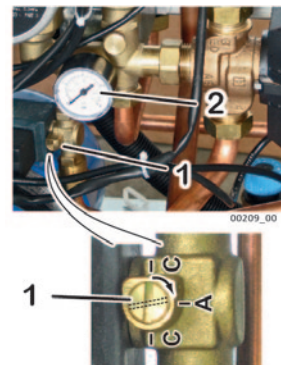

- ▶ Make sure, by reading the pressure gauge **2**, that the pressure reaches the optimal value of **1.0 bar (max 1.5 bar)**;
- ▶ Turn the screw **1** on the filling electrovalve, to position "**C**" and bleed each radiator again;
- ▶ Repeat the venting and pressurization operations until the air is completely purged from the system.

Gas connection

Due to various installation possibilities, the gas cock **3** supplied with the original Connections Kit has a simple male $\varnothing \frac{1}{2}$ " connection, facing the rear of the boiler. *The gas pipe 4, upstream the gas cock 3, should be supplied by the installer.*



While connecting gas inlet pipe of the boiler to the pipe coming from gas network, it is MANDATORY to insert a PLAIN GASKET, whose dimensions and material must be adequate. Connection is NOT suitable for hemp, teflon strip or similar materials. Because of the type of fitting, the use of those materials does not make the suitable seal with consequent gas leaks!



This boiler is designed and prepared to be supplied with Natural Gas G20 (Methane) or Commercial Propane G31. A qualified technician can convert it to operate with one of these two types of gas above said.

It must never be used with Butane gas G30 (that can be present, pure or mixed with Propane G31, in the portable gas bottles for cookers) therefore, if the boiler is prepared for operation with commercial Propane G31, we recommend notifying the supplier of the fuel, for example, by applying the sticker provided with the boiler (or included in the G31 conversion kit), on the gas tank or in its immediate vicinity, so that it is visible to the employee when it is being refilled.



Using Propane gas G31, it is absolutely necessary to install a pressure reducer upstream the boiler. Failure to do this, the gas valve of the boiler will get damaged.



The gas connection, as generally the boiler installation, must be done by qualified personnel as prescribed by the regulation in force, because a faulty gas connection could lead to fire, explosion and other very serious damages to persons, animals and objects. The manufacturer cannot be held responsible for any damage arising from that situation.

▶ Verify what follows:

- cleaning of all system gas pipes in order to avoid the presence of work residuals that could compromise the correct boiler functioning;
 - gas line and ramp conformity with laws and rules currently in force;
 - internal and external tightness of the gas system and connections;
 - supply pipe must have a section greater than or equal to the boiler one;
 - supply gas must correspond to the one for which the boiler has been set: otherwise, it's mandatory to ask to qualified personnel to set the boiler for the correct gas type;
 - an interception valve must be installed upstream the appliance.
- ▶ Open the meter valve and purge the air that is inside the system pipes (including all the appliances).

Electrical connections



The link of the room thermostat works with a safety extra low voltage (SELV); connect it to the voltage free contacts of the room thermostat/chronothermostat. **On NO account must any electrical voltage be applied** to these terminals.



All low-voltage wirings (e.g. Room Thermostat or Chronothermostat for trade) must be kept separate from power supply cables, as to avoid boiler malfunctioning due to electrical noise. It is advisable to use separate tubes for them.

The boiler must be connected to a 220÷240V - 50Hz electrical power supply. In any case, the power supply voltage must be within the range -15% ... +10% from the nominal value (230V); otherwise it may cause malfunctions or failures. It is necessary to respect the polarities L-N (Live L=brown; - Neutral N=blue) - otherwise the boiler may not work - and the earth connection (yellow-green cable).



Place upstream the boiler a bipolar switch in compliance with the regulation currently in force. The installation must be made complying the regulation currently in force and generally with the standard craft rules.

For the general electrical supply of the appliance the bipolar switch should be used. The use of adaptors, multiple taps and extensions is not allowed.

If the supply cable must be replaced, use one of the following cable types: H05VVF or H05-VVH2-F.



The supply cable replacement must be done by qualified personnel.

It is mandatory the earth connection in accordance with the rules actually in force. To replace the cable, open the control panel cover, unlock its fastening device and disconnect it from the terminals. Install the new cable proceeding in the reverse way. When connecting the cable to the boiler, it's mandatory:

- to leave the Earth wire about 2 cm longer than the other (Live and Neutral) wires;
- to lock the cable upstream the terminals by means of the suitable fastening device.



Electrical safety of the appliance is only achieved when it is well connected to an efficient earthing system, executed as indicated by the safety rules actually in force.

A qualified technician must check that the electrical system is in line with the maximum power allowed by the boiler, indicated on the data plate, with particular attention to the cables section.



ITALTHERM S.r.l. declines any responsibility for damages to persons, animals or things caused by the faulty or missing connection of the boiler earthing and by failure to comply with the rules.

Flue systems

Installation of the flue inlet/outlet flange gasket



IMPORTANT: For a correct and safe operation of the boiler it's necessary to install, on the inlet/outlet flange **2**, the gasket **1** included in the boiler's documents bag. Before inserting the flue outlet pipe it's therefore very important to correctly place the gasket on its seating as indicated in the figure.



General indications

To grant the functionality and efficiency of the appliance it is indispensable to realize inlet and outlet ducts using flue accessories specific for condensing boilers.

(i) **WARNING:** the specific flue accessories components for condensing boilers, especially the parts which are in touch with the flues inlet, are so projected because they are made with **plastic materials acids resistant**, but because of their nature, **they are not suitable to resist to the higher temperature** of the flues of the traditional boilers. So **it is not possible to use traditional flue components for the outlet ducts of the condensing boilers, neither vice versa.**

(i) When installing the pipes, we recommend lubricating the inside of their gaskets exclusively with **silicone** lubricants since their material (EPDM peroxide) is not compatible with other types of oils or greases

If it is possible, we recommend to foresee (referring to the direction of the air/flue, see examples on page 31) an upwards slope for all the inlet and outlet ducts, in order to:

- ▶ **PREVENT** the water or dust or other objects entrance inside the INLET duct. In case of coaxial ducts, use the special horizontal terminal, which is especially built to respect these slopes only for the first tract of the inlet duct;
- ▶ **FACILITATE**, in the OUTLET duct, the flowing back of the condense towards the combustion chamber, which is built to work in these conditions and to discharge the condense. If so it is not possible, or if there are some points where the condense stagnates inside the outlet duct and if it is not possible to avoid this through a modification of the slope of the ducts, these points must be drained using the specific kit of condense collector (consult the commercial catalogues of the original accessories), and ducting the condense formed towards the outlet duct as foreseen by the norms in force in matter of condensing boilers.

Air inlet and flue outlet terminals should be protected by suitable approved flue accessories, to avoid environmental elements penetration.

Carefully follow the indications foreseen by the specific laws in force.

Respect the minimum and maximum flue length prescribed (see "Flue system types" on page 30).

In case of flue outlet on wall, the positions and the distances prescribed by the regulation must be respected.

The **outlet duct is the assembly of components that connect the boiler to the point where the flues are discharged.** The outlet can be directly outdoor only in the case foreseen by the law in force and using at the end of the outlet duct a specific terminal.

In case you foreseen to discharge the combustion products through **a chimney** (for single user) or **a common flue** (for multiple users) the part of the evacuation system (the chimney or the flue) to which the outlet duct of the condensing boilers is connected, **must be declared suitable for this purpose by its producer**. In case of common chimney, keep in mind the laws in force regarding the typologies and rates of users.

Don't lean the flue pipe into the chimney, but stop it before the inner surface of the chimney. The axis of the flue pipe must intersect the axis of the chimney or of the flue duct.

In general situations the **evacuation systems** of the combustion products **must be properly declared suitable from the producer of the same system** for wet functioning, **or must be supplied by the appliance's producer** (gas boiler).

If the chimney (or the flue) were not suitable, it would be indispensable, to use it, to canalise it through specific ducts, so for example through the original flue accessories.

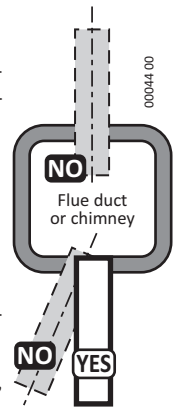

Dimensioning the inlet and outlet ducts

In the list that follows, you will find the characteristic losses of load of the original flue accessories, expressed as equivalence in meters (m).

(i) If additional, original flue accessories, aside from the ones pictured, are used, the total system length should be calculated considering the sum of the equivalent characteristic losses of load, expressed in meters in the following list.

In the case where pipes are installed with non-original accessories (this is allowed by the boiler's C6 type-approval), **but, in any case, absolutely certified for condensation**, the installer must consider the losses of load specified by the manufacturer of these accessories, dimensioning the suction and discharge system so that the total loss of load (expressed in Pa) is between the head loss values of the boiler fan specified in the paragraph "Technical data" on page 51.

Original accessories for separated systems (advised even for type C6):

Connector between boiler and $\varnothing 80$ mm inlet pipe	0.3 m - 2 Pa
Connector between boiler and $\varnothing 80$ mm outlet pipe	0.7 m - 5 Pa

Separate system $\varnothing 60$ mm (original accessories):

Reduction from $\varnothing 80$ mm to $\varnothing 60$ mm on inlet	0.4 m
Reduction from $\varnothing 80$ mm to $\varnothing 60$ mm on outlet	1.7 m
Linear section or extension $\varnothing 60$ mm length 0.5m on inlet	0.5 m
Linear section or extension $\varnothing 60$ mm length 0.5m on outlet	0.5 m
Linear section or extension $\varnothing 60$ mm length 1m on inlet	0.9 m
Linear section or extension $\varnothing 60$ mm length 1m on outlet	1 m
Linear section or extension $\varnothing 60$ mm length 2m on inlet	1.8 m
Linear section or extension $\varnothing 60$ mm length 2m on outlet	2 m
90° bend $\varnothing 60$ mm on inlet	1 m
90° bend $\varnothing 60$ mm on outlet	1.6 m
45° bend $\varnothing 60$ mm on inlet	0.5 m
45° bend $\varnothing 60$ mm on outlet	0.8 m
T-shaped condense collector $\varnothing 60$ mm on discharge	3 m
Inlet terminal $\varnothing 60$ mm (length 1 m)	1.4 m
Horizontal outlet terminal $\varnothing 60$ mm (length 1 m)	1.4 m
Vertical outlet terminal $\varnothing 60$ mm (length 1 m)	1.3 m

Coaxial system $\varnothing 100/60$ mm (original accessories):

Flanged coaxial connector $\varnothing 100/60$ mm (starting vertically)	0 m
Flanged coaxial 90° bend $\varnothing 100/60$ mm (starting horizontally)	2 m
Coaxial linear section or extension $\varnothing 100/60$ mm (length 1 m)	1 m
90° coaxial bend $\varnothing 100/60$ mm	2 m
45° coaxial bend $\varnothing 100/60$ mm	1.5 m
Horizontal condense collector $\varnothing 100/60$ mm	0 m
Horizontal inlet + outlet coaxial terminal $\varnothing 100/60$ mm (length 1 m)	1.5 m
Vertical inlet + outlet coaxial terminal $\varnothing 125/80$ mm (length 1 m, connector $\varnothing 100/60$ mm)	1 m

Flue system types

Split pipe system (C₄₃, C₅₃, C₈₃, C₉₃ *)

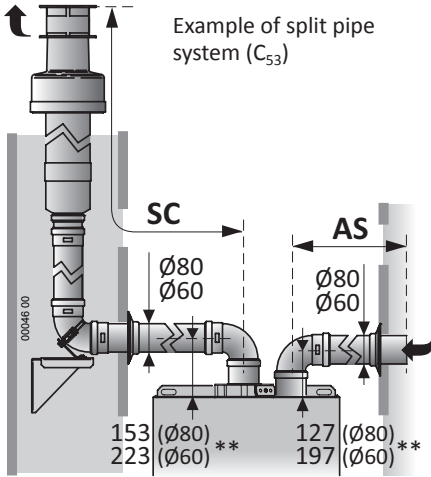

Mod.	Original*** split pipe system Ø80mm	
	AS+SC min÷max (m)	SC max (m)
35 K	2 ÷ 51	50

Mod.	Original*** split pipe system Ø60mm	
	AS+SC min÷max (m)	SC max (m)
35 K	2 ÷ 11	10

* **Remark:** Split pipes allow to make also C₁₃ and C₃₃ flue systems.

** The dimensions on the duct axis are referred to the upper edge of the boiler's body, close to the mouth of the first 90° bend. The difference of level due to the slopes are not considered.

*** **IMPORTANT:** this table is referred to the original flue accessories. Using **non-original** flue accessories (certified for condensation, whose use is allowed by the boiler's C6-type certification) refer to paragraph "Dimensioning the inlet and outlet ducts" on page 29.

Coaxial system (C₁₃, C₃₃)

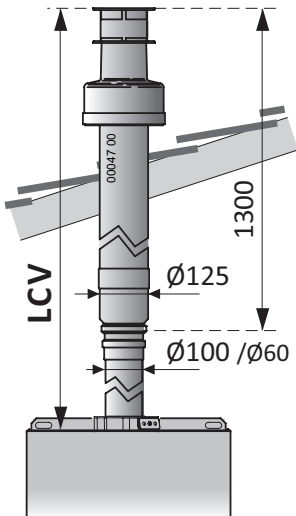

Example of vertical coaxial system (C₃₃)

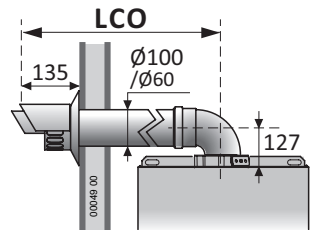
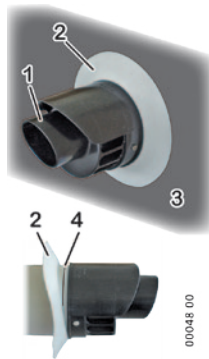

Example of horizontal coaxial system (C₁₃)



Put the outlet coaxial horizontal terminal with the outlet head 1 UPWARDS, as indicated in the picture, respecting the measures in the drawing. Check that the elastic sealing collar 2 is housed in the groove 4 and against the outside wall face 3.

Mod.	Original*** coaxial system Ø60/100 mm	
	LCO min÷max (m)	LCV min÷max (m)
35 K	1 ÷ 8	1 ÷ 10

Examples of installation of inlet and outlet ducts

We give you some correct and wrong examples of installation of inlet and outlet ducts for condensing boilers (the slope are voluntarily represented in an exaggerated way).

A = Inlet; **S** = Outlet. **1**: the most functional and economic solution is to let the condense come back towards the boiler. **2-3**: if an obstacle prevents to install the ducts upwards, it is necessary to install condense collectors, so as to avoid stagnations. **4**: the slope upwards of the inlet ducts, for their all length or at least only for the external tract, is sufficient to prevent that the rain water reaches the combustion chamber. **5**: so the inlet must not be downwards. **6**: do not let the condense go out from the flue outlet terminal. **7**: the coaxial inlet/outlet duct must be installed so as the flues are upwards, and so the condense discharge itself towards the boiler. The terminal tract with inlet head and outside with an outlet out axis must be horizontal placed and it is equipped with ribs which prevents the water entrance in the external inlet duct. The internal outlet duct is upwards and canalises the condense in the correct direction.

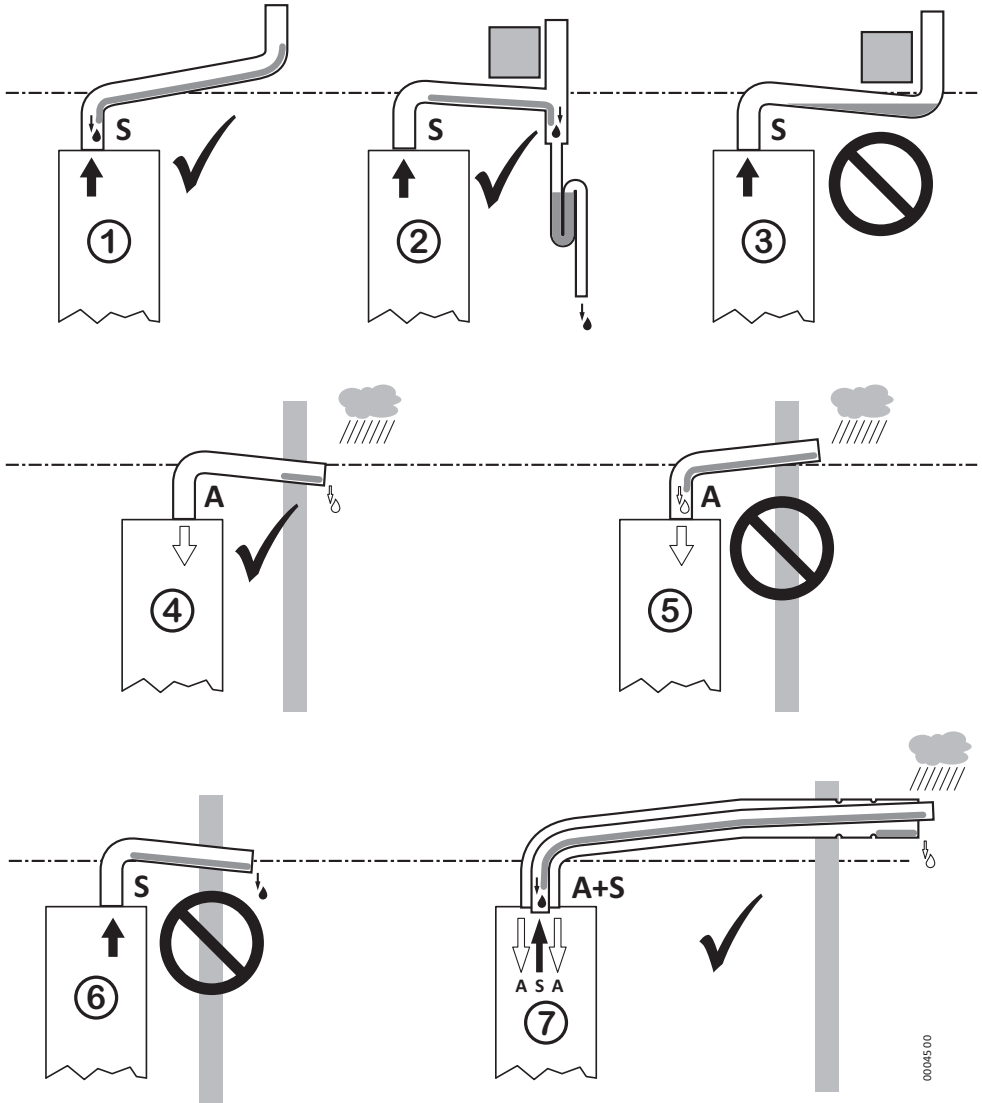

00045.00



Adjustment and Maintenance



ATTENTION: the operations described below must be carried out only by qualified personnel [authorized by ITALTHERM].



When regulation/measuring is over, remember to tighten pressure tapping point screws and to verify the absence of gas leakages only from net pressure plug (PIN, see the picture of the gas valve) and from the connection upwards the gas valve.



The gas valve, exception the PIN plug and the upwards connections, works in NEGATIVE PRESSURE. We do not recommend to use products for the detection of the gas leakages where not expressly indicated, because these products could penetrate inside the gas valve disturbing its normal functioning.



Do not use free flames to detect gas leakages!



The siphon is an integral part of the combustion system and it's necessary to check its seal during every technical intervention on the boiler. Verify that both caps (upper and lower) are properly and completely screwed.



Verify that the combustion products do not go out from the outlet of the condense.



The condense syphon trap of the boiler is equipped with a special device which closes when dry. Anyway, the seal is guaranteed only when the syphon trap is filled with liquid. So, at the end of the first firing / commissioning operation, it is recommended to check that the syphon trap contains liquid, e.g. checking that liquid exits the condense drain of the boiler.



Before firing the boiler, **check that the pump is not blocked** due to inactivity: **unscrew the plug** in the centre of the cap to **access the rotor shaft** and manually **rotate it** using a screwdriver or other suitable tool.



During the commissioning of the **new boiler**, it is necessary to **run the burner for 30 minutes before checking the combustion** because, in that period of time, any residual fabrication vapours could cause false results in the combustion products analysis.

***Remark:** during the first 10 minutes of electrical power supply, the re-ignition delay in heating mode might be nil.*

- *The ignition electronics does several ignition attempts, to avoid blocking the boiler when the ignition fails sporadically.*
- *When the gas supply pipe is filled with air (e.g. in case of new installation) it may be necessary to repeat the ignition cycle several times.*
- *The boiler is factory regulated and tested. Anyway it's advisable, during the commissioning, to check that the regulation is correct.*

First starting up

The first ignition operations consist in verifying the correct installation and functioning, and in the eventual regulations which are necessary:

- ▶ verify that the data of the plate correspond to those of the net supply (electrical, water, gas);
- ▶ verify the absence of the gas leakages from the connections upwards the boiler;
- ▶ verify the proper realization and the efficiency of all the boiler connections (water, gas, heating system and electrical system);

- ▶ verify the presence of the permanent air/ventilation outlets, correctly dimensioned and working, as foreseen by the National and Local laws depending on the appliances installed;
- ▶ verify that the evacuation flue duct corresponds to the National and Local laws and that is in good and efficient conditions;
- ▶ verify the correct functioning of the system of the outlet condense, also in the external parts of the boilers, i.e. the eventual condense collector installed on the flue outlet: verify that the liquid flow is not obstructed and that there are not inlets of gaseous combustion products inside the system itself;
- ▶ verify that the passage of the air burning and the evacuations of the flues and of the condense will be made correctly accordingly to National and Local laws in force;
- ▶ verify that the conditions for the air ventilation are granted, in case of a boiler placed inside a piece of furniture;
- ▶ vent the primary exchanger, proceeding as described in the paragraph "Venting the primary exchanger" on page 35;
- ▶ verify and, if necessary, change the boiler electronic settings to adapt its work to particular system requirements (see "Electronic settings" on page 41);

(i) Before turning on the boiler, verify that the pump is not blocked due to inactivity: unscrew the cap located at the centre of the pump's body, locate the rotor shaft behind the cap and turn it manually using a screwdriver or other suitable tool.

- ▶ verify that the combustion is correctly regulated: go on in this chapter as described in the paragraph "Combustion test and adjustment" on page 39;

(i) During the first ignition of the brand new boiler, it is necessary that burner works for at least 30 minutes, before performing combustion checks. During this time, the fumes of the eventual residual manufacturing materials are produced, and they could alter the measured values.

- ▶ verify the correct functioning of the boiler in heating and domestic hot water version;
- ▶ fill in the foreseen documentation and leave to the user the copy of his competence.

Maintenance operations

The periodically maintenance operations consist in cleaning the main parts of the boiler, in the further functioning proof (especially those described by the laws in force), and in the eventual regulations, which could be necessary:

- ▶ verify the absence of the gas leakages from the connections upwards the boiler;
- ▶ verify the conformity, efficiency and good conditions of the connections to the boiler (water, gas, heating and electrical system);
- ▶ verify the presence of the permanent air/ventilation outlets, correctly dimensioned and working, as foreseen by the National and Local laws depending on the appliances installed;
- ▶ vent the primary exchanger, proceeding as described in the paragraph "Venting the primary exchanger" on page 35;
- ▶ clean the burner, the exchanger and the funnel of the condense: go on as described in the paragraph "Combustion group cleaning" on page 35;
- ▶ check that the internal parts of the boiler are in good condition and clean;
- ▶ verify that the passage of the air burning and the evacuations of the flues and of the condense will be made correctly according to National and Local laws in force;

- ▶ verify the correct functioning of the system of the outlet condense, also in the external parts of the boilers, i.e. the eventual condense collector installed on the flue outlet: verify that the liquid flow is not obstructed and that there are not inlets of gaseous combustion products inside the system itself;
- ▶ verify that the conditions for the air inlet are granted, in case of a boiler placed inside a piece of furniture;
- ▶ when prescribed, or if it is necessary (i.e. if you find excessive residual in the combustion group or in the funnel of the condense), verify that the combustion is correctly regulated: go on in this chapter as described in the paragraph "Combustion test and adjustment" on page 39;
- ▶ verify the correct functioning of the boiler in heating and domestic hot water version;
- ▶ fill in the foreseen documentation and leave to the user the copy of his competence.

Access to the inside of the boiler

1. Remove the boiler's front panel (see "Moving the boiler" on page 20);
2. loosen screws **1** and release the control panel support plate **2**;
3. hook the plate **2** to the left column of the boiler's frame, by means of the tongues **3** and the slots **4**;

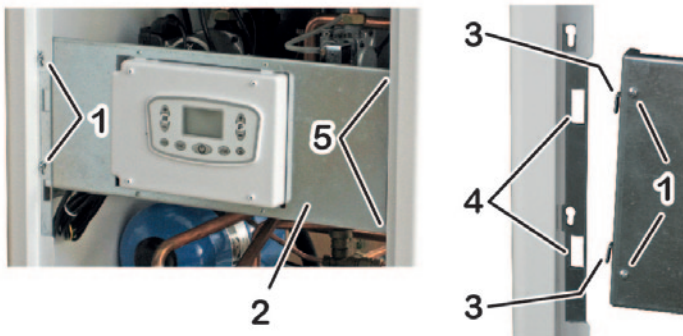

Remark: it could be necessary to screw in the screws **1** fully.

4. When reinstalling the plate **2** in its original position, insert the tongues **5** into the relevant slots in the right column.



Venting the primary exchanger

When commissioning and cleaning the combustion unit, it is a good idea to check that there is no air in the primary circuit of the combustion unit and, if necessary, to eliminate it by opening the valve **4** located on the top of the unit.

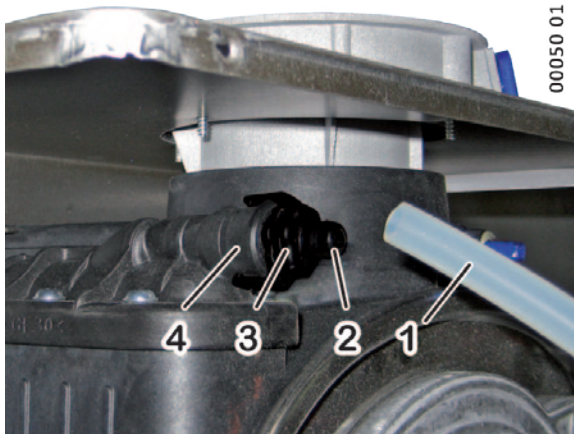

00050 01

- ▶ To avoid wetting the sealed chamber inside, use a length of flexible hose **1**, with suitable diameter, on the fitting **2**;
- ▶ slowly open the venting valve by manually turning the ferrule **3** counter-clockwise;
- ▶ when no more air comes out, close the venting valve by manually turning the ferrule **3** clockwise, without forcing excessively.

Combustion group cleaning



Switch off the boiler and disconnect it from the electrical supply.



Be sure that the parts are not hot and eventually wait the time necessary to cool them;



Because some contacts with the fine dust and acid condense may occur, we recommend to wear the proper devices for the personal protection (i.e. glasses, gloves, masque)



Warning: do not wash or damage the insulating coverings inside the combustion chamber.

- ▶ Open the sealed chamber;
- ▶ disconnect the two fan connectors **9**;
- ▶ disconnect the connectors **11** from the ignition electrode **2** and from the flame detection electrode **12**. **Attention:** do not dismantle the electrodes from the combustion group;
- ▶ unscrew the nut **4** which fixes the gas pipe **5** to the mixer assembly;

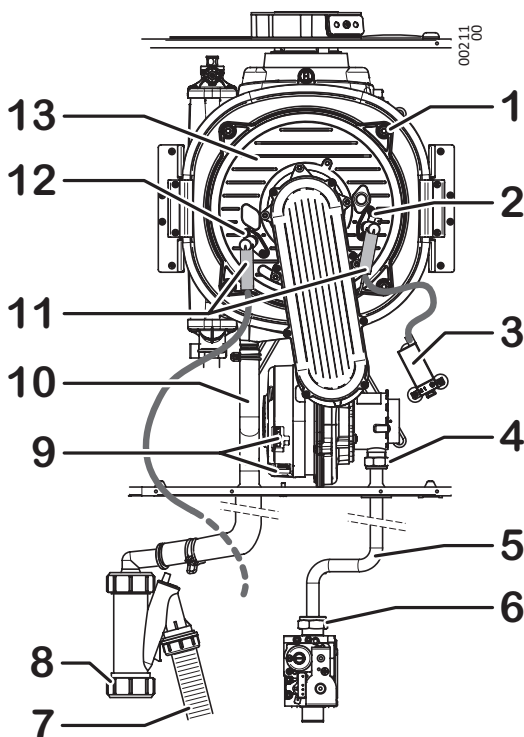

00211 00

- ▶ unscrew the 4 nuts **1** which fix the burner group **13** (composed of fan, hose and burner) to the primary exchanger. Remove the burner group;

(i) Do not disassemble the burner group and do not dismount the ceramic fibre plate from the bottom of the exchanger.

- ▶ check the integrity of the insulating coverings inside the combustion chamber;
- ▶ on the burner cover, check the integrity of the fireproof fibre gasket and of the silicone rubber one;
- ▶ check that the burner do not present deposits, foulings or excessive oxidations and that all the holes are free;
- ▶ clean softly the burner electrodes, avoiding to bend it or to move it;
- ▶ clean the cylinder of the burner **ONLY IF IT IS NECESSARY** and only **DRY**, through a **NOT METALLIC** brush, with movements on the burner's axis, from cover outwards;

(i) Do not damage the insulating coverings inside the combustion chamber and don't deform the holes of the burner. If the burner works correctly, it will be of black colour but clean or in any case with few deposits, not scaled and easy to remove.

- ▶ slip off the outlet condense pipe **10** from the connection on the primary exchanger. It's advisable to plug on the connection a suitable pipe, to divert outside the boiler (and especially out of the condensate syphon) the dust that detaches from the primary exchanger during the cleaning;
- ▶ **to clean the primary exchanger:**
 - prior to brushing the exchanger's coils, carefully remove, by a powerful vacuum cleaner, the solid residuals of combustion; don't use air jets;
 - then clean the primary exchanger coils by a **NOT METALLIC** brush and remove the residuals again by using the vacuum cleaner;

- ▶ locate the lower cap **8** of the siphon (where you can access from the lower side of the boiler, behind the returned connector of the system), put a collector for liquids under it. Unscrew the cap. Let the siphon empty itself. Inside the cover a layer of residual could be present (max 1÷2mm): remove it;

Remark: *an excessive quantity of residual is an indicator of malfunctioning or in any case it is not a normal situation. Locate the reasons and solve the problem, so remove the siphon unscrewing the superior and lateral connectors, and the screw of its support bracket. Accurately clean the siphon and be sure that its condense inlet pipe **10** and condense outlet pipe **7** are clean and not obstructed.*

- ▶ Reassemble all the components in the backwards order and opposite sense and check the combustion.

PCB parameters settings (technician menu)

These settings are reserved to Technician only. The procedure how to get in the boiler parameters is known by technician only thanks to a combination of steps which allows to gain the boiler parameters.

A few of these settings allow to optimise and tailor the boiler working, while a few others allow to set the boiler during maintenance operation.

The digits under the symbol **.III** on the left side of the display indicates the number of the parameter. Instead, the number on the right side (usually under the symbol **F** or by the shown number placed at the bottom side of the display) is referred to the parameter value (setting) the parameter is set on.

(i) In case of PCB replacing, check all of the parameter settings otherwise set them properly.
Please, do not modify any firm setting if this is not required.

Main boiler parameters (PC)

The parameters listed in the following table are limited to those described in this handbook. The complete parameter list is available in the documentation for the technician.

Parameter	Adjustment range (factory setting)	Description
01	0-1 (*)	Type of GAS supply: Value 0 = for Natural Gas (G20) supply Value 1 = for Commercial Propane (G31) supply <i>Note (*)</i> : The factory setting depends on the gas type arranged in factory for the boiler.  To change the type of gas supply, it is necessary to follow the complete instructions described in the paragraph "Gas conversion" on page 42.
03	—	It indicates the CH boiler power during the soft ignition phase. We recommend to leave the factory setting unchanged.
04	0...99 (99)	It indicates the CH boiler power according to the maximum nominal boiler power (maximum boiler power is determined by the gas valve regulation). See details in "Max heating power adjustment" on page 40.
12	0-1 (0)	Burner ignition, not modulated, to allow the combustion check. For deeper details see paragraph "Combustion test and adjustment" on page 39. Value 0 = burner at minimum power Value 1 = burner at maximum power <i>Note</i> : During this function mode, there are no burner temporization time before restarting once the primary system get the limit temperature. It means that at each burner power off, the burner will rapidly fire up again.
13	—	Minimum fan speed (in rpm x 100). Don't change the factory setting. The range and the value depend on the boiler model and on the parameter 01 (Natural Gas G20 or Propane G31 supply setting).
14	—	Maximum fan speed (in rpm x 100). Don't change the factory setting. The range and the value depend on the boiler model and on the parameter 01 (Natural Gas G20 or Propane G31 supply setting).

Parameter	Adjustment range (factory setting)	Description
15	1...10 (3)	<p>Pre-ventilation time</p> <p>Just before the burner ignition, the combustion chamber gets pre-ventilated with air, for a time that allows to remove eventual residuals of the previous combustion and so to optimise the ignition itself. Practically, the factory setting suits all the cases, and we suggest to leave it unchanged. Note that the boiler ignites the burner only after the pre-ventilation time, so increasing this time means to delay the response of the boiler to working requests (e.g. a DHW request).</p>
16	10...30 (10)	<p>Post-ventilation time</p> <p>Just after the burner shutdown, the combustion chamber gets post-ventilated with air, for a time that allows to remove eventual residuals of the combustion and so to optimise the next burner ignition. This operation removes most combustion products so that the next pre-ventilation (controlled by the parameter 15) can be the shortest. Practically, the factory setting suits all the cases, and we suggest to leave it unchanged. The post-ventilation is interrupted in case of working request, so this setting doesn't affect the boiler response.</p>
17	20...78 Zon1 1 temp.: high: (45) low: (78)	<p>TA2 input setting (flow temperature during a CH request from the Secondary Room Thermostat only)</p> <p><i>The boiler can manage a secondary room thermostat installed in a zone that must be heated with a different typology compared to the one where the primary room thermostat (or the original Remote Control) is installed. E.g. it's possible to foresee (with suitable hydraulic system solutions to distribute the heating to the various zones) a zone with a low temperature heating system (e.g. the primary one, controlled by the primary room thermostat or the original Remote Control) and one with radiators (controlled by the room thermostat TA2). The advantage of this management is that, when only the low temperature system requires heating, the boiler can work in low temperature and therefore condensing, with all the consequent advantages. This technical parameter adjusts the system temperature for the secondary zone controlled by the TA2, that can be made with radiators or low-temperature, so the adjustment range (20÷78°C). The user can't adjust the system temperature in the zone managed by the TA2 (of course he can adjust the room temperature in the secondary zone, by means of the TA2 itself).</i></p>
18	0...1 (0)	<p>Current fan speed display</p> <p>By setting to 1 the value and exiting the Technical Menu, the current fan speed (in rpm x 100), physically measured by a suitable device incorporated in the fan motor, will be shown on the display for 15 minutes. This information is useful during troubleshooting.</p> <p> Use this function during the normal functioning of the boiler, WITHOUT switching it in stand-by.</p>

Combustion test and adjustment

(i) Before checking the combustion, clean the burner and the exchanger as described in the paragraph "Combustion group cleaning" on page 35 (except for the case of first ignition).

To check and adjust the boiler you need a **flue analyser, correctly calibrated** (in the condensing boiler, the precision and the correctness of the measures is particularly important). Then, through a suitable function on the panel, we ignite the burner, first with a reduced flow and then at the maximum flow, doing the measure and adjustments in both conditions. Proceed as follows:

1. The boiler should be electrically supplied and in **OFF** mode. If necessary, use the button  (OFF is shown on the lower side of the display);
2. on the flue flange, unscrew the screw **1** and move the tapping insert **2** in such a way to tap the inlet plug **A** only; insert the analyser probe in the flue plug **F**, taking care of the seal of the connection;

Remark: The sensor placed at the top of the flue probe must be placed as possible in the centre of the flow outlet: we advise you to insert well the sensor and so to extract it of 3 cm. Insert the sensor so that the protection bow of the sensor, placed at the top, is transversal (the flow must pass through it and directly touch the sensor).

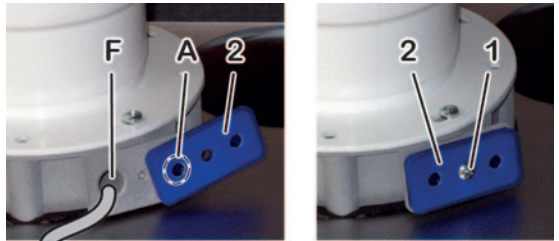

(i) Generate a heating request by activating the room thermostat and be sure that the heat produced by the boiler can be eliminated by the heating system (through the radiators and/or radiant panels/floor systems).



3. activate the boiler to its **minimum output not modulated**, using the "Chimney-sweeper" function, that activates by entering the technician menu and setting the parameter **12** to value **0** (see also "PCB parameters settings (technician menu)" on page 36);
4. making reference to the following table, check that the centre of the display shows the correct value for the **number of revolutions per minute at Qr** for the **type of gas used** (you are reading the number of fan revolutions per minute x100 at reduced flow capacity; for example, the value 14 means that the fan is rotating at 1400 rpm);

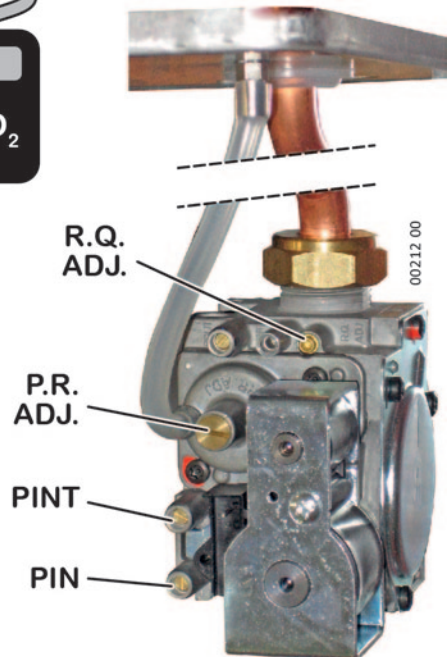

Heat input	Natural gas G20		Commercial propane G31	
	CO ₂ %	Fan rpm x 100	CO ₂ %	Fan rpm x 100
Reduced Q _r	8.7 ±0.5	see "Power input / display / fan rpm tables" on page 41	9.6 ±0.5	see "Power input / display / fan rpm tables" on page 41
Nominal Q _n	9.2 ±0.5		10.3 ±0.5	

- wait for the boiler to come up to full operation (about 5 minutes). If the value of **CO₂** in the fumes, at the reduced input **Q_r** for the **type of gas used**, is within the range shown in the table, go to step **6** to check/adjust the nominal input, otherwise you will have to bring the CO₂ back within the correct values, changing the offset by turning the screw **P.R. ADJ.** (the adjustment screw is inside the bushing, under the screw cap). **ATTENTION: turn the screw 1/8 of turn at a time and then wait 1 minute** to allow the CO₂ value measured by the analyser to stabilize;
 - If the **CO₂** value is **HIGHER** than allowed, **DECREASE** the off-set by turning the screw **P.R. ADJ. COUNTERCLOCKwise**;
 - If the **CO₂** value is **LOWER** than allowed, **INCREASE** the off-set by turning the screw **P.R. ADJ. CLOCKwise**;
- don't quit the technical menu and activate the boiler to its **maximum output not modulated**, using the parameter **12** to value **1**;
- the burner ignites at the nominal power. Wait for the boiler to come up to full operation (about 5 minutes). If the **CO₂** value in the fumes at nominal input **Q_n** for the **type of gas used** is between the values shown in the table, quit the technical menu (the boiler turns **OFF**), otherwise you will have to adjust the gas input by turning the screw **R.Q. ADJ.** . **ATTENTION: turn the screw 1/4 - 1/2 of turn at a time**, waiting 1 minute for the values measured to stabilize:
 - If the **CO₂** value is **HIGHER** than allowed, turn the screw **R.Q. ADJ. CLOCKwise**;
 - If the **CO₂** value is **LOWER** than allowed, turn the screw **R.Q. ADJ. COUNTERCLOCKwise**;

Remark: if you have adjusted the CO₂ at the nominal input, we advise you to check again the CO₂ and the off-set at the reduced input (steps 3 to 5).
- set the parameter **12** to value **0** and quit the technical menu (see also "PCB parameters settings (technician menu)" on page 36). The boiler turns **OFF**;



IMPORTANT: at the end of the check or the adjustments, it is INDISPENSABLE:

- close, on the gas valve, the pressure plug **PINT** by turning the specific screw;
- close the flue plugs used, by restoring the tapping insert **2** and the screw **1**, caring that the plastic surface of the flange is not damaged or worn;
- seal the screw cover of **P.R. ADJ.** and the screw **R.Q. ADJ.** if they have been used;
- check the correct flue system tightness, especially the tightness of the tapping insert **2**.

Max heating power adjustment

The maximum heating power output must be set in accordance with the system requirements (stated in the project). Power input values, corresponding fan rpms and relevant display indications are listed in the "Power input / display / fan rpm tables" on page 41.

- Get information about the maximum heating power requirement of the heating system (reported on the project documentation of the system itself);



Ensure that the heat produced by the boiler can be eliminated by the heating system (through the radiators and/or radiant panels/floor systems).

- enter the technician menu (see "PCB parameters settings (technician menu)" on page 36), select the parameter **04** and get ready to change its value. The burner ignites;
- set the parameter **04** to the value that corresponds to the required power input (refer to the "Power input / display / fan rpm tables" on page 41);

Remark: the value from 00 to 99 that appears on the display during the setting, is foreseen to be read at the end of the adjustment and to be eventually re-used as a quick reference to set the boiler again to the same heating power.

- To switch the burner off, quit the technician menu (see also "PCB parameters settings (technician menu)" on page 36). The boiler switches to OFF mode.

The MAX power for the heating system is adjusted now.

Power input / display / fan rpm tables

	G20			INDICATIVE VALUE par. 04	G31		
	HEAT INPUT		FAN RPM		HEAT INPUT		FAN RPM
	kW	kcal/h			kW	kcal/h	
Time Compact 35 K	MIN. 3.4	2924	1200	0	MIN. 5.0	4300	1500
	5.6	4816	1660	10	7.0	6020	1975
	7.3	6278	2150	20	10.1	8686	2385
	10.2	8772	2620	30	12.9	11094	2770
	14.5	12470	3080	40	16.3	14018	3170
	18.2	15652	3560	50	19.0	16340	3550
	21.8	18748	4040	60	21.7	18662	3955
	24.7	21242	4510	70	24.5	21070	4360
	27.9	23994	4980	80	27.0	23220	4750
	30.2	25972	5450	90	29.4	25284	5130
	MAX. 33.0	28380	5900	99	MAX. 33.0	28380	5500

Electronic settings

Accessing the main board

To access the main board:



Cut off the electrical supply to the boiler. Restore the supply after having closed the control panel rear cover.

- after having hooked the control panel support plate as described in "Access to the inside of the boiler" on page 34, unscrew the screws **1** and remove the back cover of the control panel.

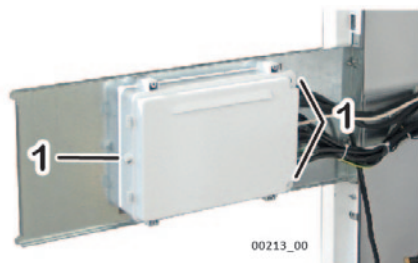

Main board settings

ON the PCB there are **6 micro-switches SW1÷SW6** and two trimmers **P1 and P2**.



Disconnect the power supply before approaching the micro-switches. Restore the power supply only after you have closed the back cover of the control panel.



Changes to micro-switches and trimmers status have no effect until the boiler is electrically supplied (they are red during the board startup, when the supply is connected).

In all of TIME boilers model range, the settings must be as follows, otherwise the boiler does not work properly:

- ▶ micro-switches SW1÷SW5 in OFF position and SW6 in ON position. **Look out:** in case of PCB replacement, set the micro-switch SW6 to ON on the new, spare PCB.

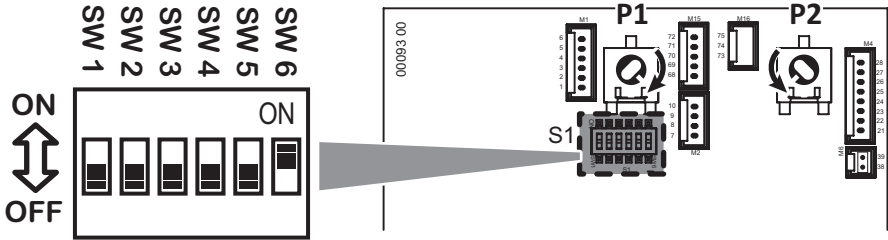

- ▶ the P1 and P2 trimmers position is indifferent, anyway it's suggested to leave them set as in the firm: P1 fully turned clockwise and P2 fully counterclockwise, as shown in the figure.

Gas conversion



ATTENTION: the operations described below must be carried out only by qualified personnel [authorized by ITALTHERM S.r.l.].

For gas conversion, use the components supplied by boiler manufacturer only.



Using Commercial Propane G31, it is absolutely necessary to install a suitable pressure reducer upstream the boiler.



This boiler is designed and prepared to be supplied with Natural Gas G20 (Methane) or Commercial Propane G31. A qualified technician can convert it to operate with one of these two types of gas above said.



It must never be used with Butane gas G30 (that can be present in the portable gas bottles for cookers) therefore, it's important to inform, about this, the supplier of the fuel.

1. Enter the technician menu (see "PCB parameters settings (technician menu)" on page 36) and set the parameter 01 on the required gas kind the boiler is required to work with:
 - 0 = Natural gas (G20),
 - 1 = LPG (G30/G31)
2. disconnect the boiler from the electrical supply. Remove the boiler cover as described in the paragraph "Access to the inside of the boiler" on page 34.
3. ensure that the inlet gas pressure complies with the required nominal pressure (see "Technical data" on page 51) and that the gas flow is sufficient to guarantee the appliance correct work.
4. open the sealed combustion chamber.
5. slip off the silicone hose 1 from the fitting 2 of the sealed chamber compensation plug;
6. unscrew the calibrated plug 2 and replace it with the one in the conversion kit. The connector to use with Methane G20 is "silver" coloured and the one for Propane G31 is "brass" coloured; then, insert the silicone hose 1 on the sealed chamber compensation plug again;
7. open the sealed chamber, loosen the swivel nut 5 that connects the gas pipe 6 to the mixer assembly 3;
8. unscrew the three screws 4, remove the mixer assembly 3 and replace it with the one supplied in the conversion kit;

9. screw the swivel nut **5** replacing the gasket;
10. close the sealed chamber;
11. check, with the burner on, that the pressure upstream from the boiler is:
 - **Natural gas (methane) G20** = min.17 - max.25 mbar
 - **Commercial Propane G31** = min.35 - max.40 mbar

For detailed setting values, refer to the table "Technical data" on page 51.
12. check the combustion as described in the preceding paragraph "Combustion test and adjustment" on page 39 checking that the fan speed automatically change;
13. apply the label indicating the type of gas (provided with the kit) in the area provided on the "WARNING" plate inside the boiler;
14. in the case of liquid gas fuel, it is important that the boiler be exclusively fuelled with commercial Propane G31 and not with Butane G30. For this reason, we recommend that the supplier of the fuel be informed, for example, by applying the sticker provided in the conversion kit on the gas tank or in its immediate vicinity, so that it is visible to the employee at the time it is being filled.

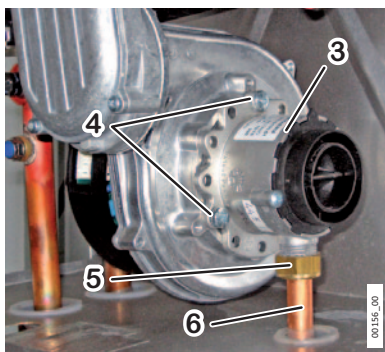
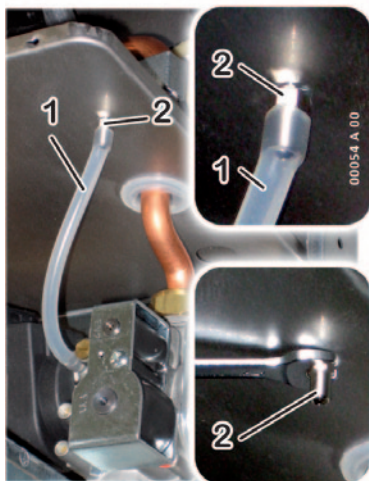

Draining the system

When it is necessary to drain the system, use the draining tap **1**:

- ▶ Unscrew the cap **3**;
- ▶ connect a rubber pipe to the draining tap terminal **4** ;
- ▶ put the other end of the pipe in a suitable drain or sink;
- ▶ open the draining tap by turning the nut **5** counterclockwise;
- ▶ when the pressure is COMPLETELY drained, it's possible to open the radiators venting valves, to allow the air inlet. The complete system drain is possible only draining the liquid from the lowest point of the system itself.
- ▶ when everything is over, close taps (turning the nut **5** clockwise) and air vents;
- ▶ screw the cap **3** on the terminal **4**.

(i) In the primary exchanger a certain quantity of water of the heating system remains. If you want to move the boiler, we advice you to close with plugs the hydraulic inlet/outlet heating system connections.

- ▶ Drain the storage unit if necessary (storage tank and/or primary coil) carrying out the operations described below.

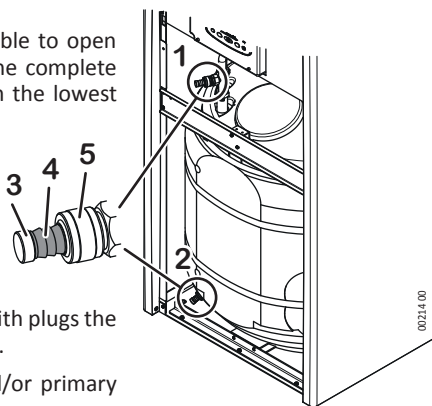

Draining the storage unit

When it is necessary to drain DHW storage, use the draining tap **2** located at the bottom of the storage unit:

- ▶ Close the hand valve installed on the boiler's cold water inlet connection;
- ▶ connect a rubber pipe to the terminal of the storage draining tap **3**;
- ▶ put the other end of the pipe in a suitable drain or sink;
- ▶ open the draining tap by turning its hand nut counterclockwise;
- ▶ when the draining is over, close the draining tap (turn it clockwise).

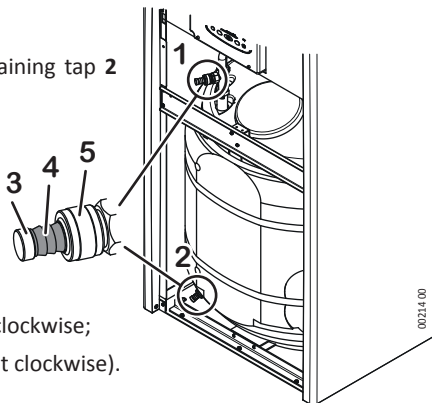

Alarms - boiler block







Following a malfunction, the boiler can lockout and show a particular signal, **RESET** or **SERVICE** on the display, with an alarm code "E...". In the following table, all the alarm signals are listed, their most probable causes and the suggested solutions. Generally:



- **RESET** identifies those **alarms the user can restore** by pressing the **RESET** button. It normally **blinks**, but after 5 reset actions in 24 hours the action on the **RESET** button has no more effect. *To have 5 further reset possibilities, it's possible to switch off the electrical supply to the boiler for 30 seconds, by using the purposed external switch, even if this work-around won't solve the problem and it will be necessary to call the Service Centre;*
- **SERVICE** identifies those **alarms the user can not restore**, as they are generated by the diagnostic system when a component has been detected as faulty. *The user is allowed to switch off the electrical supply to the boiler for 30 seconds, by using the purposed external switch, but should the alarm happen again, it will be necessary to call the Service Centre.*









Operations accompanied by the symbol  are always reserved to the Technician. Operations with grey background are reserved to the Technician.

Signal	Probable causes	Suggested solutions
RESET E01	Boiler just installed (air mixed to gas).	Retry the ignition several times: use the RESET button. <i>When the 5 reset possibilities are over, to have 5 more, it's possible to switch off the electrical supply to the boiler for 30 seconds, by using the purposed external switch.</i>
	The flame has extinguished or it did not ignite	Restore the boiler function by using the RESET button.  In case of frequent blocks, verify the correct combustion, the good state and the cleaning of the burner.

Signal	Probable causes	Suggested solutions
	 Incorrect combustion / flame detachment from the burner	<p>Check that the Inlet/Outlet Ducts and the respective terminals are clean and in good condition, and that there are no leaks in them. During the installation, respect the regulation prescriptions, the slopes and the lengths (see "Flue systems" on page 27).</p> <p><i>Note for the TECHNICIAN: The burner flame is not detected by the control electronics because it has not turned on or it has suddenly turned off, or it has detached from the burner, because of an incorrect combustion. This can be due, in example, to combustion product reflow into inlet duct, leaks in inlet/outlet ducts or errors in sizing of ducts (ducts length out of the allowed range, and/or wrong use of the reducer on boiler's outlet).</i></p>
	 Incorrect electrical power supply	<p>Ensure that the Live, Neutral and Earth connections are correct and efficient and in particular that the Live and Neutral are not swapped (see "Electrical diagram" on page 54).</p> <p><i>Remark: The problem could also be caused by an incorrect distribution of electricity on the network (neutral unbalanced).</i></p>
	 Condensate drain problem	<p>Verify and restore the correct condensate drain.</p> <p> Warning! DO NOT open the combustion assembly before having cleared the drain and removed the condensate accumulated in the combustion chamber. <i>This alarm is caused by the condensate that, after having partially filled the combustion chamber, reaches the detection electrode and inhibits the detection of the flame ionisation.</i></p> <p>Then, check the combustion and verify that the burner is clean and in good conditions.</p>
RESET E02	the boiler has overheated and the Safety Thermostat has triggered	<p>Restore the boiler function by using the RESET button. If necessary, wait at least 20-30 minutes (to make the boiler cool) and try again. If the lockout persists or reappears, call the Service Centre.</p> <p> Verify the safety thermostat functionality. Detect the causes of the overheating, e.g. an insufficient circulation in the primary circuit; max gas pressure out of the limits or maximum heating power excessive for the heating system size.</p>
SERVICE E03	 The overheat thermal fuse of the combustion assembly has triggered (combustion assembly overheating)	<p>Solve the problem that caused the overheating, then replace the combustion assembly.</p> <p><i>Note for the TECHNICIAN: the condensing combustion assembly has overheated and the relevant thermal fuse has blown. This is an extreme protection that normally is anticipated by other safety thermostats. If, in case of fault, those devices should not trigger and the burner should get hotter and hotter, the thermal fuse will cause the block of the boiler to avoid damages to building and furniture, but the combustion group must be considered damaged and therefore it must be replaced.</i></p>
	The flue overheat thermal fuse has triggered (flue on boiler outlet too hot)	<p>Solve the problem that caused the overheating of the flue, then replace the flue thermal fuse.</p> <p><i>Note for the TECHNICIAN: the flue thermal fuse preserves the flue ducts (that are made with Polypropylene, a material suitable to the condensate acidity) from the high temperatures, that could lead to their fusion or deformation. The triggering of this device consists in its blowing and therefore it must be replaced.</i></p>
SERVICE E05	 Failure to the system flow temperature probe.	<p>Check the cabling of the system flow temperature probe.</p> <p>Replacement of the system flow temperature probe.</p>

Signal	Probable causes	Suggested solutions
SERVICE E09	Periodical Service maintenance	Call Service Technician for planned maintenance operations. <i>Pushing RESET, User can cancel this for 3 times. After that the signal remain on display. Even with this signal present, boiler is still working properly.</i>
RESET E10	Low system pressure and SW6 wrong setting.	 Disconnect the electrical supply to the boiler. On the main board, check that the microswitch SW6 (that enables the automatic system filling) is switched to ON as described in the paragraph "Electronic settings" on page 41. During re-activation, it's possible that an automatic filling cycle is performed (see "E18").
SERVICE E12	Failure to the DHW storage temperature probe.	Check the cabling of the DHW storage temperature probe. Replacement of the DHW storage temperature probe.
SERVICE E15	Failure to the heating system return temperature probe.	Check the cabling of the system return temperature probe. Replacement of the system return temperature probe.
RESET E16	Fan failure. The burner fan is stopped or rotates at an incorrect speed.	User: Try a boiler reset by using the RESET button. If the lockout persists or reappears, call the Service Centre. Check the burner fan functionality, especially its speed, by using the parameter 18 (see "PCB parameters settings (technician menu)" on page 36). Replace it if necessary.
RESET E18	Automatic filling in progress	The CH system water pressure was insufficient for the normal functioning so the boiler started the automatic water filling in the CH system. Once the right pressure is achieved, the error code automatically disappears and the boiler restart the normal function.
SERVICE E19	Automatic filling in not completed after 4 minutes.	During the automatic filling in (see "E18") the system pressure does not achieve the right value within the preset time. Maybe due to: <ul style="list-style-type: none"> • inlet water pressure from the net is not sufficient (see "Technical data" on page 51); • inlet water cannot enter the boiler for likely closed tap installed in the inlet way. <p>Try to restart the boiler by powering the boiler off for 30 second and the power that on again from the bipolar switch.</p>  Filling in valve is blocked/broken/or it is not electrically supplied • Inlet filters are clogged • Big quantity of scale in the water • Big loss of water in the CH system.

Signal	Probable causes	Suggested solutions
SERVICE E21	Low system pressure <i>(after the four filling in attempts)</i>	<p>The boilers has filled in water (see “E18”) for three times within the latest 24 hours, but now the system pressure has dropped again. Likely there is a loss of water in the CH system.</p> <p>Try to restart the boiler by powering the boiler off for 30 second and the power that on again from the bipolar switch. <i>During the power-up, an automatic filling in cycle could start (see “E18”).</i></p> <p><i>Note: it is possible to experience this alarm code during the first filling in when the boiler is just installed due to bleeding of air from the system. For this reason, at the first time the boiler get electrically supplied, the number of fillings allowed before showing the error code are 5 and not 3 for the first 24 hours after the installation.</i></p> <p><i>Remark: Consider that the pressure, in normal conditions, should not decrease with the progress of the time. If this happens, there is probably a loss in the heating system. Sometimes the loss is so small that it doesn't leave evident signs, but with the progress of the time it can cause the decreasing of the pressure. Also the opening of the manual venting taps of radiators (intentional or unintentional) makes the pressure decrease. Check that this doesn't happen.</i></p> <p> Loss in the heating system.</p>
SERVICE E22	Memory-stored data not coherent.	<p>User: Disconnect the electrical supply to the boiler by operating the suitable external bipolar switch, then connect it again after a few minutes. If the lockout persists or reappears, call the Service Centre.</p> <p>Redo all the boiler settings ("Max heating power adjustment" on page 40 and "Electronic settings" on page 41) to update the data in the main board memory.</p> <p>Replace the main board (consequently, redo the "Max heating power adjustment" on page 40 and "Electronic settings" on page 41).</p>
RESET E24	Floor heating system safety thermostat triggering:	<p>The floor heating system and the floor cladding can be damaged by temperature shocks, so a good quality system includes one or more safety thermostats that, if necessary, trigger and lock the boiler.</p> <p>Try a boiler reset by using the RESET button (eventually wait for a period that allows to cool the system and restore the thermostat). If the lockout persists or reappears, call the Service Centre</p> <p><i>Remark: when this alarm is active, the hot water production is locked too.</i></p> <p> If any floor heating system was installed, check the integrity of the jumper connecting terminals 57 and 58 of M12 see "Electrical diagram" on page 54).</p> <p>If the floor heating system is installed, check the system flow temperatures on the boiler and on the low temperature system kits (if installed). Replace the faulty or out-of-tolerance thermostats. Check the correct positioning of the thermostats on the system (see "Floor heating system" on page 18).</p>
SERVICE E31	Communication error between the Remote Control (if present) and the boiler	<p>User: select the Summer mode using the button .</p> <p>Problems on the optional Remote Control connection link (passing close to supply cables or other electromagnetic field sources; connection failure; cable length over 50 meters).</p>

Signal	Probable causes	Suggested solutions
SERVICE E33 E34 	Cabling configuration error.	<p>User: Try a boiler reset by using the RESET button. If the lockout persists or reappears, call the Service Centre.</p> <p>Refer to the electronic diagram (page 54) and check the integrity of the wirings, especially the eventual short cable jumpers between two contacts of the same connector (on the cabling connections to the electronic board).</p>
RESET E35 	Unexpected flame the control electronic has detected the flame on the burner when this one should be off	<p>Wait for the boiler automatic reset (5 minutes) or reset it manually by using the RESET button. If the lockout persists or reappears, call the Service Centre</p> <p>Detect eventual malfunctioning of the gas valve (that does not stop fully the gas flow, so the burner remains ignited) or of the electronics, flame detection section (that detects the flame presence even if it's absent).</p>
SERVICE E38 	Failure to the outdoor temperature probe (optional). The outdoor temperature probe, that was recognized and working, now results faulty.	<p>User: Call the Service Centre.</p> <p><i>The boiler now works either in heating and in hot water, like as the external boiler had never been installed, so the heating system temperature is set directly and not as a function of the outdoor temperature. The alarm is displayed to inform that the accessory is no more efficient (consider that, on a first analysis, the boiler seems to work perfectly). Important: if the boiler is turned off and then on again, it's possible** that the alarm is no more displayed, even though the problem persists.</i></p> <p>Check the cabling of the outdoor temperature probe.</p> <p>Replacement of the outdoor temperature probe.</p> <p><i>** The alarm shows again only if the resistance of the probe is out of tolerance or in short-circuit. On the contrary, if the probe or the relevant cabling is interrupted, when the electrical supply is restored the boiler will consider the external probe absent and, in Winter mode, it will work in normal mode (temperature shifting disabled).</i></p>
SERVICE E39	Suspected freezing After a power failure, the boiler detected temperatures at the Heating and DHW probes equal to, or less than, 0°C when power was restored	<p>The display shows the alarm code 39 while the boiler inhibits the ignition of the burner and activates the circulator, forcing water to circulate in the hydraulic circuits.</p> <p>If, during this time, the temperatures measured by the probes rise above +1°C, the alarm is reset and the boiler returns to the normal operation.</p> <p>Otherwise, the alarm will persist and you should suspect that water has frozen at one or more points of the hydraulic circuit of the boiler and/or system (with possible damage to the frozen parts). If the alarm persists, call a qualified technician.</p> <p>Find/replace the parts damaged by the freezing.</p>
SERVICE E42 	System error Anomaly of inner boiler device(s) Mains electrical power supply out of tolerance limits	Detect the fault or anomaly also referring to the technical literature reserved to the service centres.

Signal	Probable causes	Suggested solutions
RESET E43	Over-temperature of water on system return	<p>The water that returns to the boiler from the heating system is too hot: this may be an effect of a malfunction of the system, and anyway this can cause a too high temperature of the flue and damage the flue system. Before this happens, a suitable safety protection has triggered.</p> <p>Wait 20-30 minutes to let the boiler and the system cool down, then reset it manually by using the RESET button. It is impossible to restart the boiler before the cooling of the system. If the block happens again, please call a qualified technician.</p>
SERVICE E46	Cabling configuration error.	<p>User: Try a boiler reset by using the RESET button. If the lockout persists or reappears, call the Service Centre.</p> <p>Refer to the electric diagram (page 54) and check the integrity of the wirings, especially the eventual short cable jumpers between two contacts of the same connector (on the cabling connections to the electronic board).</p>
SERVICE E50	Electric supply out of tolerance for 3 times in last 5 minutes.	Verify, with qualified person, that Electric Supply and its tolerances are respecting "Technical data" on page 51.
SERVICE E62	Communication error between the Display Board and the Main PCB.	<p>Refer to the electric diagram (page 54) and check the integrity of the wirings between the Display Board and the Main PCB.</p> <p>Replace the Display Board and the Main PCB.</p>
SERVICE E91	System pressure transducer failure.	<p>Check the cabling of the system pressure transducer.</p> <p>Replacement of the system pressure transducer.</p>
SERVICE E92	Excessive system pressure.	<p>User: Try reducing the system pressure (e.g. draining some water from the purging valve of a radiator or similar) and eventually press the RESET button. It could be useful to set the display of the system pressure, that normally should be about 1 Bar (ved. "Set the display with 4 digits" on page 11).</p> <p>If the lockout persists or reappears, call the Service Centre.</p> <p>Check the efficiency of the expansion vessel.</p> <p>Check the correct shutting of the filling electrovalve, the efficiency of the relevant filter and the presence of solid particles in the electrovalve body.</p>
SERVICE E93	Filling in not completed - reached the water amount limit.	<p>The boiler detected an excessive amount of water entered in the heating system during the filling cycle(s).</p> <p>If you don't detect traces of leaks (that might be the cause of the effective alarm), try to restart the boiler by powering the boiler off for 30 second and the power that on again from the bipolar switch.</p> <p>If the lockout persists or reappears, call the Service Centre.</p> <p> Leak in the system • Specific technical parameter (disabled by factory default) set on a too low value.</p>

Signal	Probable causes	Suggested solutions
E98	System clock data loss	<p>The clock/calendar of the boiler is out of date, likely because of a long power supply failure.</p> <p>Adjust the clock again (see "Hour and day setting" on page 11) and check/restore the eventual DHW program (see "Setting the DHW storage program no. 3 - User" on page 12).</p>

Warnings for servicing



All servicing operations and gas conversions **MUST BE CARRIED OUT BY QUALIFIED TECHNICIANS**, in compliance with the norms and laws in force (see an indicative list on page 4). Moreover, **MAINTENANCE** operations must be carried out in compliance with the manufacturer prescriptions and with the laws and rules presently in force, for the parts not mentioned in this handbook; we advice to perform them at least once a year to maintain the boiler's performance.

A careful servicing is always a guarantee of safety and energy saving. Normally, it will be necessary to execute the following operations:

- ▶ Remove any possible oxidization from burners and electrodes;
- ▶ Remove the scale from the exchangers;
- ▶ Cleaning and checking the exchanger, the siphon and all the parts which are in touch with the condense;
- ▶ Check integrity and stability of the ceramic fibre coverings in the combustion chamber and proceed eventually to substitution;
- ▶ Check and eventual substitution of the magnesium anode of the storage unit (see the documentation supplied with the unit);
- ▶ Check the boiler ignition, switching off and operation;
- ▶ Check the water and gas connections tightness;
- ▶ Check the gas consumption at the minimum and maximum output;
- ▶ Verify that safety devices are correctly working;
- ▶ Verify the correct functioning of control and adjusting devices;
- ▶ Verify periodically the absence of leaks of combustion products to the inner room, the correct functioning and the integrity of the flue outlet ducts and/or devices and of the relevant terminals and accessories;
- ▶ In case of works or servicing of the structures placed near the above mentioned ducts and /or devices and their accessories, switch off the boiler;
- ▶ Do not leave any inflammable tanks and/or substances in the installation room;
- ▶ If the boiler draws directly from the installation room (*type B appliance installed indoor*): Do not clean the room where boiler is installed, while it is working
- ▶ Clean casing with soapy water only. Do not clean casing, other painted or plastic surfaces with thinner.
- ▶ In any case of parts replacement, it is mandatory to use ITALTHERM original spare parts.

ITALTHERM declines any responsibility in case of non-original spare parts utilization.

"Once all check and servicing operations have been carried out, the technician must write a report for the user, who must countersign a copy for receipt and vision" as prescribed by the regulation in force.

Technical data

TECHNICAL DATA	U.M.	Time Compact 35 K	
		G20	G31

CE certification		0694 CM 3400	
Class		II ₂ H ₃ P	
Type		B23 - B23P - C13 - C33 - C43 - C53 - C63 - C83 - C93	
Working temperature range (min÷max)	°C	0 ÷ +60	

Max heat input	kW	33.0	33.0
Min heat input	kW	3.4	5.0
Max heat output 60°/80°C *	kW	32.0	32.0
Min heat output 60°/80°C *	kW	3.2	4.7
Max heat output 30°/50°C *	kW	34.7	34.7
Min heat output 30°/50°C *	kW	3.6	5.2
NO _x Class		5	5
CO at 0% O ₂ (Qn)	ppm	176.1	175.2
CO ₂ at nominal input	%	9.3	10.4
Condense quantity at Qn (30°/50°C *)	l/h	3.30	2.60
Condense quantity at Qr (30°/50°C *)	l/h	0.22	0.19
Condense acidity	pH	2.8	2.8
Flue temperature (Qn)	°C	78.6	79.8
Flue mass flow rate (60/80°C - Qn)	kg/h	53.02	53.87

EFFICIENCY

Nominal efficiency at 60°/80°C *	%	97.0
Efficiency at 30% load at 60°/80°C *	%	101.2
Nominal efficiency at 30°/50°C *	%	105.1
Efficiency at 30% load at 30°/50°C *	%	107.6

* system return / flow water temperature

Remark: data have been measured with horizontal coaxial flue, length = 1 m.

(follows)

TECHNICAL DATA (cont'd)	U.M.	Time Compact 35 K	
		G20	G31

Gas type

HEATING

Temperature selection range (min÷max) <i>Main heating circuit, normal range / low temp. range</i>	°C	35÷78 / 20÷45
Temperature selection range (min÷max) <i>Secondary heating circuit</i>	°C	20÷78
Characteristics of the heating system water (or filling liquid) <i>(* = if aluminium parts are present along the system)</i>	°f pH	5 ÷ 15 °f pH 7.5 ÷ 9.5 (7.5 ÷ 8.5 *)
Expansion vessel	l	12
Expansion vessel pre-loading pressure	bar	1
System pressure for automatic filling turning ON/OFF	bar	ON a 0.5 / OFF a 1.2 (±0.2) <i>To allow the correct system filling, the pressure of the domestic water should be higher than the OFF value.</i>
Max working pressure	bar	3
Max system temperature	°C	85
Anti-freezing function temperature on / off	°C	5 / 30

HOT WATER

Storage volume	l	120
Specific flow rate (EN625)	l/min	22
DHW expansion vessel	l	5
DHW expansion vessel pre-loading pressure	bar	3 <i>(see also "DHW storage tank filling" on page 24)</i>
Max supply pressure <i>(storage safety valve threshold)</i>	bar	8
Storage temperature selection range (min÷max)	°C	30 ÷ 60

ELECTRICAL DATA

Voltage / frequency (nominal voltage)	V / Hz	220÷240 / 50 (230V -15% ... +10%)
Power consumption	W	118
Level of protection		IP X5D

DIMENSIONS

Width - Height - Depth	mm	see <i>"Dimensions and connections" on page 18</i>
Weight	kg	149

CONNECTIONS

Hydraulic and gas connections		see <i>"Dimensions and connections" on page 18</i>
Flue: types, lengths and diameters		see <i>"Flue systems" on page 27</i>
Fan head loss	Pa	30 ÷ 130

(follows)

TECHNICAL DATA (cont'd)	U.M.	Time Compact 35 K	
		G20	G31
<i>Gas type</i>			

GAS SUPPLY PRESSURE

Nominal pressure	mbar	20	37
Inlet pressure (min÷max)	mbar	17 ÷ 25	35÷40
Colour of the calibrated plug for sealed chamber compensation		Grey "Silver"	Yellow "Brass"

GAS CONSUMPTION

Qmax	m ³ /h	3.49	
	kg/h		2.56
Qmin	m ³ /h	0.36	
	kg/h		0.39

Notes

Electrical diagram

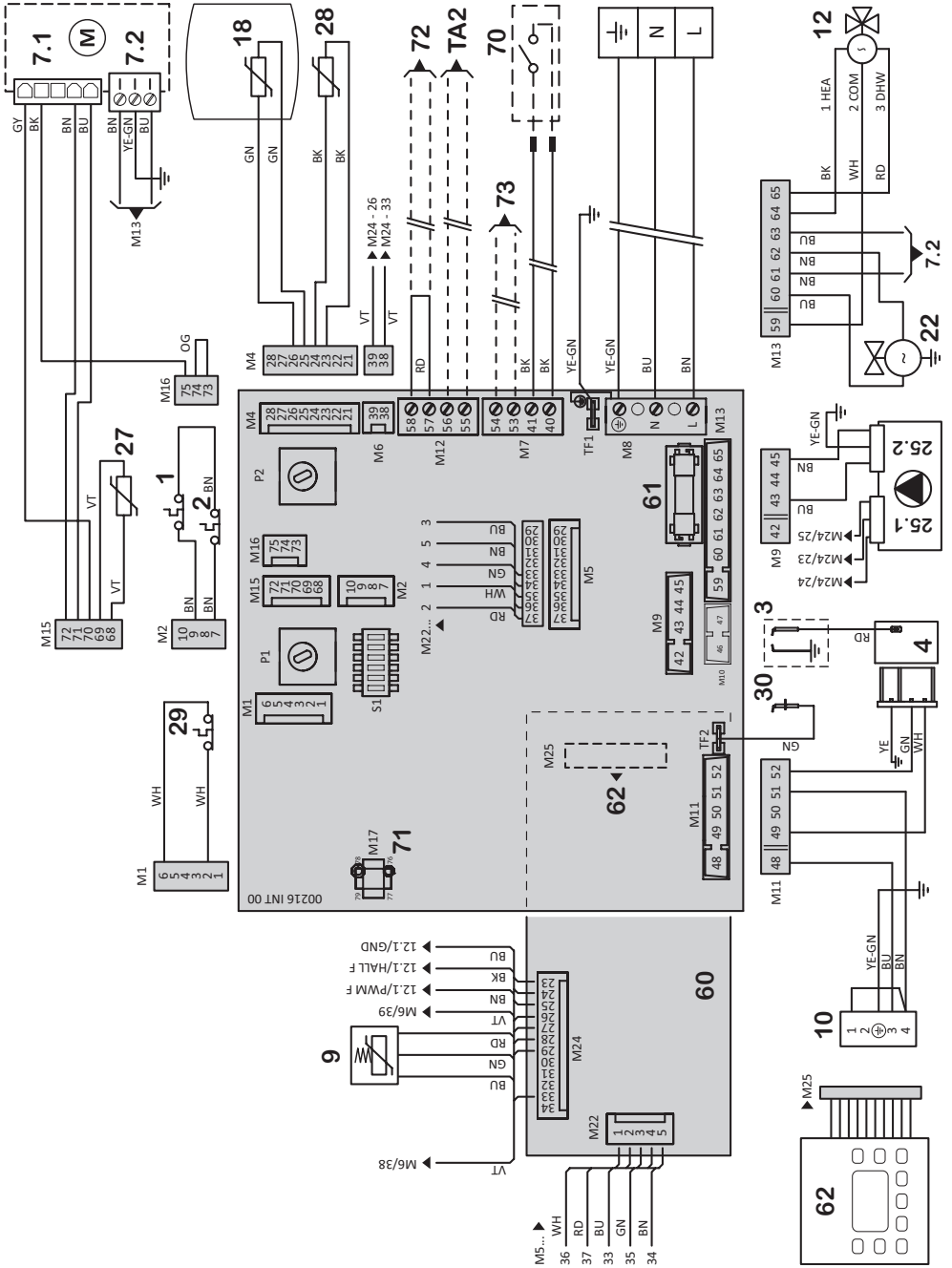

- 1 Flue overheat fuse (*)
- 2 Combustion assembly overheat fuse (*)
- 3 Ignition Electrode
- 4 Electronic igniter
- 7.1 Fan - speed control
- 7.2 Fan - supply
- 9 System pressure transducer
- 10 Gas valve - opening control
- 12 Motorized 3-way valve
- 18 Storage temperature sensor
- 22 System filling in electrovalve
- 25.1 Pump, modulating - speed control
- 25.2 Pump, modulating - supply
- 27 Temperature Sensor on system return
- 28 CH flow temperature sensor
- 29 Safety thermostat (system flow) (*)
- 30 Flame detection electrode
- 60 Display board
- 61 Fuse F2A (2A fast)
- 62 Control keyboard

(*) if the contacts of these components are shown in rest/cold conditions.

Abbreviations:

BK	Black	WH	White
BN	Brown	YE	Yellow
BU	Blue		
GN	Green	COM	Common
GY	Grey	DHW	DHW mode
OG	Orange	NC	Normally Closed
RD	Red	NO	Normally Open
VT	Violet	HEA	Heating mode

Optional external devices:

70 Room thermostat: Voltage-free Contact for Room Thermostat or Chronothermostat (for trade) working at safety extra low voltage SELV. Closed contact = heating request.

Remote control: Terminals of the original ITALTHERM remote control device. See also page 59.

To install, open the junction on the wires and connect them to the device terminals (eventually, extend the cable)

71 Connector for CH multi zones PCB kit
with remote control installed

72 To optional floor heating system safety thermostat

73 To optional outdoor temperature sensor

TA2 To optional room thermostat for zones with different temperature range

Boiler internal components

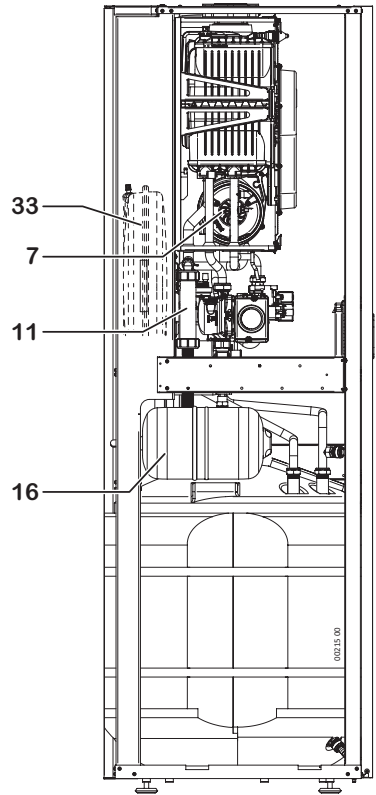
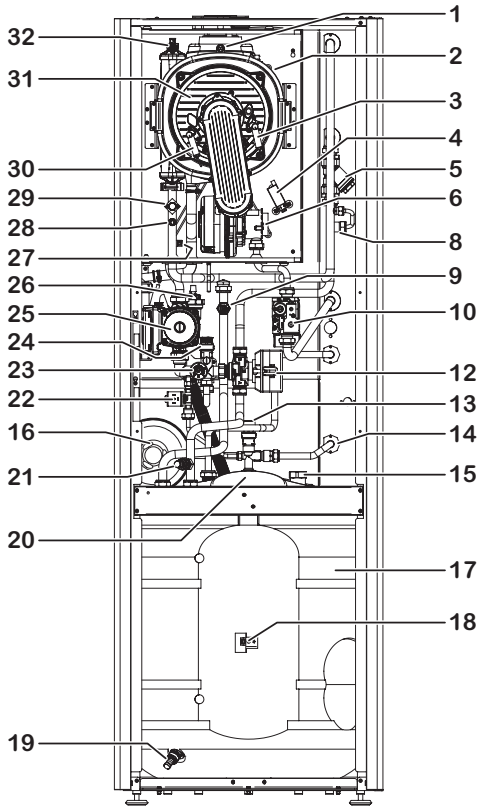

- | | | | |
|----|---|----|--|
| 1 | Flue overheat fuse | 18 | DHW storage temperature sensor |
| 2 | Combustion assembly overheat fuse (connector) | 19 | Drain valve (DHW storage) |
| 3 | Ignition Electrode | 20 | Magnesium anode |
| 4 | Electronic igniter | 21 | Drain valve (heating system) |
| 5 | Filter on system return | 22 | System filling in electrovalve |
| 6 | Air/Gas Mixing System | 23 | Gauge |
| 7 | Fan | 24 | Safety valve 3 bar |
| 8 | By-pass | 25 | Pump, modulating |
| 9 | System pressure transducer | 26 | Automatic Venting Device (heating circuit, incorporated in the pump) |
| 10 | Gas valve | 27 | Temperature Sensor on system return |
| 11 | Siphon for condense outlet | 28 | Temperature Sensor on system flow |
| 12 | Motorized 3-way valve | 29 | Safety thermostat (system flow) |
| 13 | DHW safety valve - 8 bar | 30 | Flame detection electrode |
| 14 | Filter on inlet water | 31 | Combustion assembly (burner+primary exchanger) |
| 15 | Connection for DHW recycle (optional) | 32 | Manual Venting Device (Combustion assembly) |
| 16 | DHW expansion vessel | 33 | Expansion vessel (heating system) |
| 17 | DHW storage tank | | |

Hydraulic diagram

This diagram is for information only. To make boiler hydraulic connection either see "Dimensions and connections" on page 18 and eventually "Positioning and fastening" on page 22.

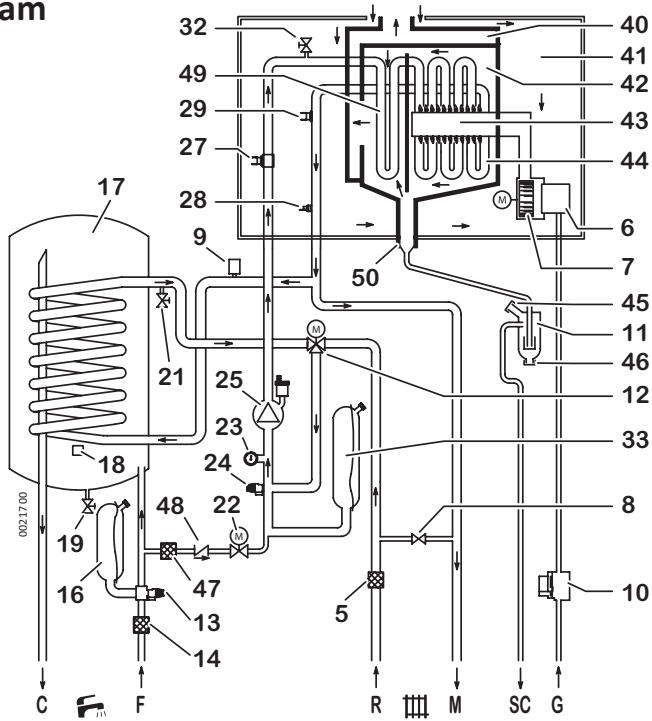

- | | | | |
|----|---|----|---|
| 5 | Filter on system return | 29 | Safety thermostat (system flow) |
| 6 | Air/Gas Mixing System | 32 | Manual Venting Device (Combustion assembly) |
| 7 | Fan | 40 | Flue hood |
| 8 | By-pass | 41 | Sealed chamber |
| 9 | System pressure transducer | 42 | Combustion chamber |
| 10 | Gas valve | 43 | Burner |
| 11 | Siphon for condensate outlet | 44 | Primary exchanger (combustion section) |
| 12 | Motorized 3-way valve | 45 | Overflow drain of condensate trap |
| 13 | DHW safety valve - 8 bar | 46 | Tap for condensate trap cleaning |
| 14 | Filter on inlet water | 47 | Water filter for filling in electrovalve |
| 16 | DHW expansion vessel | 48 | Check valve |
| 17 | DHW storage tank | 49 | Primary exchanger (condensing section) |
| 18 | DHW storage temperature sensor | 50 | Condense drain in combustion assembly |
| 19 | Drain valve (DHW storage) | | |
| 21 | Drain valve (heating system) | | |
| 22 | System filling in electrovalve | | |
| 23 | Gauge | | |
| 24 | Safety valve 3 bar | | |
| 25 | Pump, modulating (including automatic venting device) | | |
| 27 | Temperature Sensor on system return | | |
| 28 | Temperature Sensor on system flow | | |
| | | C | DHW outlet |
| | | F | Cold water inlet |
| | | R | Heating return |
| | | M | Heating flow |
| | | SC | Condense drain |
| | | G | Gas inlet |

Outdoor Sensor Kit

Installation and setting

The Outdoor Sensor manages automatically the CH flow temperature** as a function of the outdoor temperature, thus avoiding the user to adjust it manually. This function is also named "shifting temperature".

** that's the temperature of the heating elements. Don't mistake it with the room temperature (managed by the room thermostat or by the Remote Control, but not by the boiler) that doesn't depend on the first one.

The installation must be made by a professionally skilled technician following the instructions supplied with the kit. Refer to "Electrical diagram" on page 54 for the links to the Main Board.

After the installation of the Sensor, the buttons **+|||** and **-|||** described in the User section, won't adjust directly the CH flow temperature, but the dispersion factor "kd" that's the response of the outdoor temperature, detected by the sensor, on the CH flow temperature, as shown in the following graph.

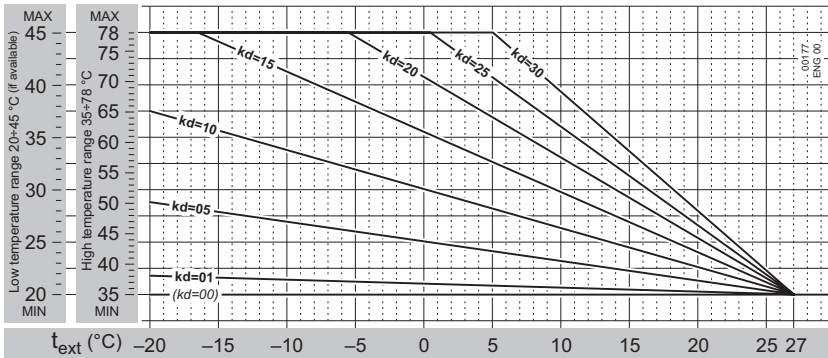

Practically, **kd** value should be adjusted depending on the estimated efficiency of the building's thermal insulation. Its range is from 01 to 30: use **higher values** when there is a **high thermal dispersion** and therefore a **less efficient insulation** (and vice versa).

(i) Because of the wide buildings typologies, it's impossible to give precise indications on kd value to set. **The correct setting must be determined case by case and will have, as a result, an optimal comfort in all the climatic conditions** requiring heating, i.e. a prompt reaching of the room temperature with cold weather and no room overheating during mild periods.

Outdoor Sensor kit and Remote Control

If also the Remote Control Kit is installed, its parameter **P04** (modulation mode) should be set on value **2** (modulating on outdoor sensor and on-off on room sensor) or **3** (modulating on both outdoor and room sensors) as described in the **paragraph 5** of the instruction booklet included in the Remote Control Kit. Afterwards, also the **kd** should be set on this latter (refer to **paragraph 8.6** of the same booklet). On the Remote Control, just because of different display, the **kd** adjustment range is **0.1...3.0** instead of 01...30.

Remote Control Kit

This remote control is **more than a simple room thermostat**. Thanks to this, it is possible to **manage the boiler in all its settings** like DHW and CH temperature adjustment, **boiler reset** in case of boiler block, and of course it works as a **room thermostat** both in **manual** and **weekly program** mode. It's powered by the boiler (in safety low voltage), so **it doesn't need batteries**.



(i) Extract the Remote Control from its package. **Keep the relevant user instruction booklet and annex it to this Manual.**



Nor the Remote Control neither the relevant cable coming from the boiler must not, for any reason, be connected to the 230Vac supply mains.



(i) To avoid malfunctions due to electrical noise, the Remote Control connections, as well as all low-voltage connections, should be kept separated from power supply cables, e.g. by enclosing it into separate raceways.

The maximum overall cable length shouldn't exceed 50 m.

(i) Install the Remote Control at approx. 1.5 m over floor in a place suitable for correct sensing of the room temperature. Do not install behind doors, curtains, near heat sources nor expose to direct sunlight or water sprinkles.

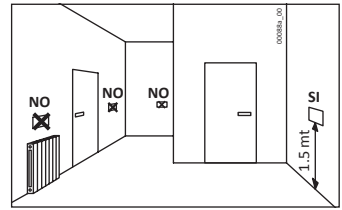

1. Cut off electricity from boiler;
2. install the device as described in the **paragraph 4** of the supplied instruction booklet;
3. link the Remote Control wirings to the "Room Thermostat - Remote Control" cable coming out of the boiler, by means of a suitable bipolar terminal. See also "Electrical diagram" on page 54;

Note: *The Remote Control link is not polarized.*

(i) Check the correct work of the device. The electronics recognizes it automatically (otherwise the alarm **E31** appears (see "Alarms - boiler block" on page 44) **provided that:**

- on the boiler's control panel, by means of the button , the **Summer** mode is forever set. Hereafter the boiler working modes (even OFF) should be selected on the Remote Control only;
- the main boiler board is set as described in "Main board settings" on page 41.



www.italtherm.it

960000071_00_ENG - 08/01/2015

ITALTHERM Srl declines any responsibility for eventual printing and/or transcription errors in the present manual. In order to constantly improve its products, the company has the right to change features and data written in the present manual, at any time and without notice.

ITALTHERM Srl

Via S. D'Acquisto, snc • 29010 Pontenure (PC) - IT
Tel. +39.0523.575611 • Fax +39.0523.575600

www.italtherm.it • e-mail: info@italtherm.it