

## CITY BASIC

### Instruction Handbook for:

- ▶ use
- ▶ installation
- ▶ adjustment
- ▶ maintenance

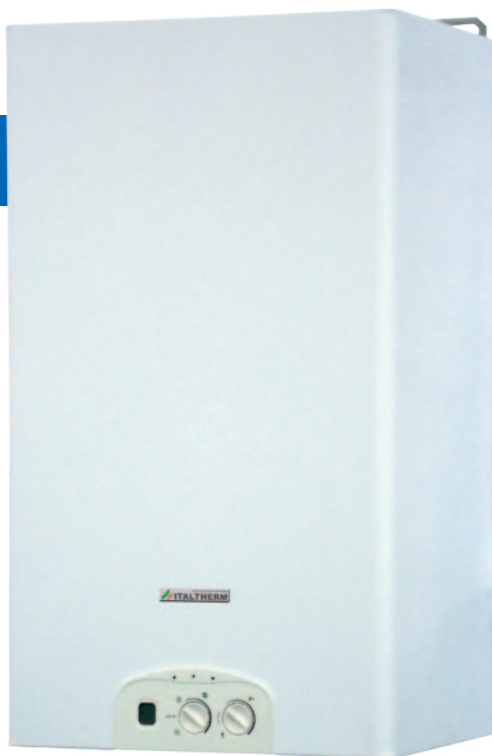

# Table of Content

---

## Safety warnings

Safety warnings symbols legend	4
References to Laws and Norms	4
Personnel in charge of installation	4
Installation, use and maintenance	4
User warnings	5
Important	5
First starting up and Use	5
Installation, first starting up, maintenance and servicing	6
Appliance booklet or central plant booklet	6
Combustion checking	6
Boiler operation and servicing	6

---

## User guide

The front control panel	7
Commands on the lower side	8
Commands outside the boiler	8
Typical use	9
Preliminary operations	9
Boiler activation	9
Temperature adjustment	9
Incidental malfunctioning	10
The burner doesn't turn on	10
Shortage of domestic hot water production	10
Boiler inactivity	11
Safety shut off	11
Stand-by mode with anti-frost & anti-locking function	11
"Ambient Anti-Frost" Function	12

---

## Installation

Law and regulation prescriptions for the installer	12
Dimensions and connections	13
Pump capacity diagram	13
Specifications for inlet air	13

Domestic water supply characteristics	14
Protection against freezing	14
Positioning and fastening	14
Hydraulic system (DHW and heating)	16
Advices and suggestions to avoid vibrations and noises in the system	16
Cleaning and preservation of the systems	16
Heating system	16
Heating system filling and pressuring	16
Gas connection	17
Electrical connections	18
Chimney connections	18
Flue terminals positioning	20

---

## Adjustment and Maintenance

First starting up	22
Access to the inside of the boiler	22
Inlet gas check	23
Max and Min pressure adjustment	23
Max heating power adjustment	24
Burner pressure tables	26
Soft ignition	26
Electronic settings	26
Accessing the main board	26
Main board settings	27
Gas conversion	28
Combustion check	29
Hydraulic settings (pump speed)	29
Draining the heating system	30
Alarms - boiler block	30
Warnings for servicing	33
Technical data	34
Boiler internal components	36
Electrical diagram	37
Hydraulic diagram	38
Remote Control Kit	39



## Safety warnings





This instructions manual is an essential and complementary part of the product and it is supplied together with the boiler.



Carefully read the manual, achieving all important information for a safe installation, use and servicing.

- ▶ **Carefully keep the manual**, together with the documentation of all the accessories of the boiler and of the system, for any further consultation you may need.
- ▶ **The installation** must be carried out by a qualified technician, in accordance with manufacturer instructions and with the relevant requirements of the current issue.
- ▶ **Carbon monoxide (CO) danger:** the CO is a no-smelling and no-colour gas. When a natural draught boiler with air inlet from the room (appliance type B<sub>1</sub>) is installed, the air supply and room ventilation system of the installation room must be made and sized in compliance with Laws and Rules in force. Whatever manumission, closing or neutralization of the permanent ventilation could lead to very serious consequences to people in the rooms, as intoxication by CO, permanent damage and death. Besides, the CO and O<sub>2</sub> mix can be explosive.
- ▶ A **qualified technician** is a person with a specific technical competence in the field of the heating appliances for domestic use and domestic hot water production, in compliance with Laws and Rules in force.
- ▶ The **operations that the user can do** are only and exclusively the ones contained in the "USER GUIDE" section.
- ▶ The manufacturer has no contractual and extra-contractual responsibility for any damage arising from wrong installation, wrong use and non-observance of current laws and instructions given by the manufacturer himself.
- ▶ **Important:** this gas boiler is used to heat the water at a temperature lower than the boiling one, at atmospheric pressure; it must be connected to an heating system and/or to a domestic hot water system, in accordance with its features and power.
- ▶ Packing items (cartons, nails, plastic bags and so on) **must not be left within children easy reach**, as they are potentially dangerous.
- ▶ **Before any cleaning or servicing operation**, disconnect the boiler from the mains electrical supply by means of the main electrical switch and stop the gas supply by means of the suitable cock.
- ▶ **In case of fault** and/or bad operation of the appliance, disconnect it immediately and do not try to repair it by yourselves.
- ▶ **Boiler servicing and repair** must be carried out exclusively by qualified technicians, which will use original spare parts. Strictly observe the above requirement, avoiding any risk of compromising the appliance safety.
- ▶ **If the appliance should be definitively dismissed**, remove or cut off any potential dangerous item.
- ▶ **When transferring the appliance** (e.g. leaving it installed after a removal or a sale of the building), make always sure that the instructions manual is close to the boiler for the future use of new owners and/or installers.
- ▶ This appliance **must be used for its clearly recommended utilization only**. Any other utilization must be considered dangerous and incorrect.
- ▶ It is strictly forbidden to use the appliance **for different purposes** than the specified ones.
- ▶ This appliance must be **installed exclusively to wall**.

# Safety warnings symbols legend

 Generic safety warning	 Electrical danger (fulguration)	 Physical danger (personal damage)
 Thermal danger (burns)	 General warning or advice to avoid material damage or to achieve improvements	

## References to Laws and Norms

 All the **references to norms and national laws** mentioned in this handbook are indicative as laws and norms are subject to issues and integrations by the authorities in charge. **Also comply to eventual local norms and laws** (not mentioned in this handbook) in force in the territory where the installation takes place.

### *Personnel in charge of installation*

Place here all necessary advices according to national rules about **WORK SAFETY** of Personnel in charge of installation. An example follows:

**Law number 192 of 19-August-2005 and further revisions** “Title of the law or brief description”.



Always proceed with caution when handling the boiler and carrying out installation/maintenance work as metal parts may cause injuries such as cuts and abrasions. **Wear personal protection devices** (especially gloves) while doing the above mentioned operations

### *Installation, use and maintenance*

Place here all necessary advices according to national rules about **BOILER INSTALLATION**, An example follows.

**Law number 412 of 26-July-1993 n°412 and further revisions** “Title of the law or brief description”.

# User warnings

## Important



In case of gas smell:

- 1 - **do not press electrical switches, use the telephone or other objects that can provoke sparks;**
- 2 - **open immediately the windows and the doors in order to cleanse the room air;**
- 3 - **close the gas supply taps;**
- 4 - **call a qualified technician.**



**Do not obstruct the ventilation openings** of the gas boiler room, in order to avoid possible dangerous situations as the creation of poisonous or explosive mixtures.

## First starting up and Use



The first starting up and the maintenance of the boiler must be performed by a professionally qualified staff (for example the installer or the Service Centres authorized by ITALTHERM)

Gas conversion from a gas of a specific family to a gas of another family (from natural gas to LPG or vice versa) to another gas, can be made also when the gas boiler is already installed, but only by a qualified technician. The technician will check that:

- ▶ the label technical data of the gas boiler correspond to those of the gas available;
- ▶ the main burner regulation is compatible with the gas boiler output;
- ▶ the chimney works correctly, expelling the combustion products;
- ▶ the air supply and the combustion products evacuation work correctly, in accordance with the requirements in force;
- ▶ the conditions for a correct ventilation are guaranteed, also when the gas boiler is located inside a closed space (with suitable characteristics).



The User must not touch sealed items nor break the seals. Only specialized technicians and the official technical service can break the seals of sealed items.



The boiler is fitted with a safety flue flow detection device that should never be bypassed or put out of order. If the pressure switch must be replaced, use the original spare part only. In case of repeated interventions of the device (and consequent boiler locks), check that the Flue Products Outlet System is efficient and made according to the laws in force (see examples in paragraph "Chimney connections" on page 18) and that the air supply and room ventilation system is efficient and made according to the laws in force.



When the boiler is off for a long period see the Paragraph "Boiler inactivity" on page 11 for the necessary precautions about the electrical supply, the gas supply and the protection against freezing.



**Do not touch the heated surfaces** of the boiler, as the doors, the flue, the chimney pipe, etc., also after the boiler operation because, for a certain time, these surfaces are overheated. **Any contact with them can cause dangerous scalds.** It is then forbidden to let children or inexperienced people be close to the boiler, during its operation.

- ▶ Do not expose the wall hung gas boiler to water or other liquids sprinklings, or to vapours directly coming from gas cookers/hobs.
- ▶ Do not obstruct the air inlet or flue outlet terminals, even momentarily or partially.

- ▶ Do not put any object on the gas boiler and don't leave any flammable liquid or solid materials, (e.g. paper, clothes, plastic, polystyrene) in its proximity.
- ▶ This appliance is not intended for use by persons (including children) with reduced physical, sensory or mental capabilities, or lack of experience and knowledge, unless they have been given supervision or instruction concerning use of the appliance by a person responsible for their safety. Children should be supervised to ensure that they do not play with the appliance. *(CEI EN 60335-1:2008-07 § 7.12)*
- ▶ If the gas boiler is going to be definitively unused, call a qualified technician to carry out all required operations, checking in particular disconnection of gas, water and electrical supplies.
- ▶ **Only for those models that draw directly from the installation room** (type B appliances installed in-door): the installation of aspirators, fireplaces or similar appliances in the room where the type B appliance is installed (and in adjacent rooms in case of indirect ventilation) is prohibited except in cases foreseen by rules in force and anyway the installation must be made in compliance with all specific safety measures mentioned in the rules and laws in force, even in case of modifications or additions.

## ***Installation, first starting up, maintenance and servicing***

All operations for installation, first starting up, maintenance, servicing and gas conversion **must be carried out by qualified technicians**, in accordance with the Norms and Laws in force.

Maintenance operations must be carried out in compliance with the manufacturer prescriptions, and in compliance with the laws and rules presently in force for what is not mentioned in this handbook; we advise to perform them at least once a year to maintain the boiler's performance.

### ***Appliance booklet or central plant booklet***

All appliances must have an appliance booklet (for outputs less or equal 35 kW) or a central plant booklet (for outputs more than 35 kW). All maintenance and servicing operations and combustion checks must be written on the booklet, together with the name of the person responsible for servicing.

### ***Combustion checking***





















Combustion checking consists of a control of the boiler efficiency. Boilers that, after the checking, will have efficiency rates lower than the ones required and not changeable with suitable adjustments (that must be performed by qualified technicians), must be replaced.

### ***Boiler operation and servicing***









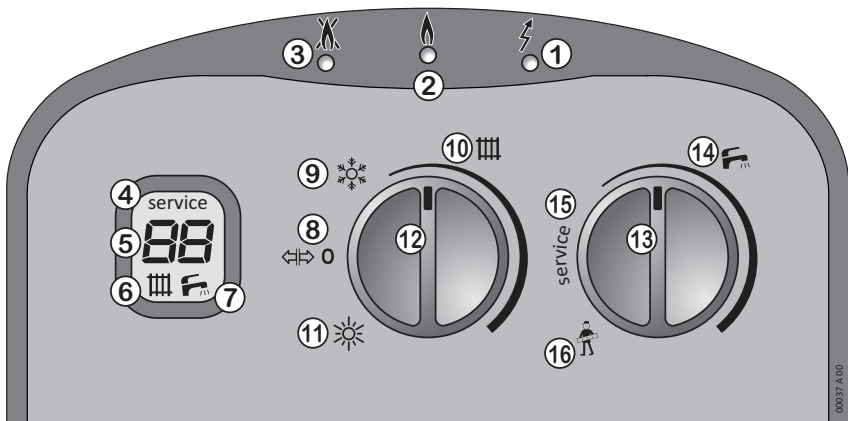



The user (owner or tenant of the flat where the boiler is installed) or the administrator of the block of flats (in case of a central heating system) are responsible for the appliance operation and servicing; they can both transfer the responsibility of the servicing and eventually of the operation to another person, which must be a qualified technician as indicated by the Laws. Even if the user or the administrator decide to assume personally this responsibility, ordinary servicing of the warm air heater and combustion checks must be anyway carried out by a qualified technician



## The front control panel

- 1  **Electrical Supply Indicator Light**  
green   
**Off** - boiler not electrically supplied.  
**Blinking** - boiler electrically supplied, but not active because the knob **12** is on  **0** .  
**On** - boiler active. Knob **12** on  , or on  along the scale  .  
**Flashing with short pulses** - actuated for mistake, by the user, a *function reserved to the technician*. Rotate immediately the knob **13** back on the scale  .
- 2  **Burner Indicator Light**  
yellow   
**Off** - the flame in the burner is off.  
**On** - the flame in the burner is on.
- 3  **Alarm Indicator Light**  
red   
**Off** - no problems detected.  
**Blinking or Flashing** - see "Alarms - boiler block" on page 30.
- 4 **service** Indication, on the display, for the Technician, usually not displayed.
- 5 2-digit number on the display Normally it indicates, in °C, the temperature of the water going out of the boiler (heating or domestic).  
During the adjustment of the heating system temperature (rotating the knob **12** along the scale  ) or domestic hot water (rotating the knob **13** along the scale  ) it shows the set value, in °C.
- 6  -  Usually, they are shown in **fixed mode** and they indicate that the boiler is ready to supply heat to the relevant heating  or DHW  . When the boiler is in Summer mode  , the symbol  is not shown.
- 7  on the display They **blink** during the actual heat delivery, by the boiler, to the relevant system.



8		Position on which the knob <b>12</b> should be positioned to turn the boiler off or to reset a boiler block.
9		Position on which the knob <b>12</b> should be positioned to activate the boiler in Winter mode (both Heating and Domestic Hot Water functions available).
10		Scale on which the knob <b>12</b> should be positioned to adjust the Heating system temperature.
11		Position on which the knob <b>12</b> should be positioned to activate the boiler in Summer mode (only Domestic Hot Water function available and exclusion of Heating)
12	<b>boiler mode</b>	Knob that allows to switch the boiler in OFF mode  <b>8</b> , Summer  <b>11</b> or Winter  <b>9</b> and to adjust the Heating system temperature  <b>10</b> .  If the Remote Control Kit is installed, see "Remote Control Kit" on page 39.
13	<b>DHW</b>	Knob that allows to adjust the Domestic Hot Water temperature (along the scale  <b>14</b> ). The use of the positions <b>15</b> and <b>16</b> is reserved to the technician.
14		Scale on which the knob <b>13</b> should be positioned to adjust the Domestic Hot Water temperature.
15	<b>service</b>	Positions of the knob <b>13</b> which use is reserved to the technician.
16	 	Do not turn the knob <b>13</b> on these positions.

## Commands on the lower side

- 17 System pressure gauge
- 18 System filling and pressure restoring cock
- 19 GAS cock

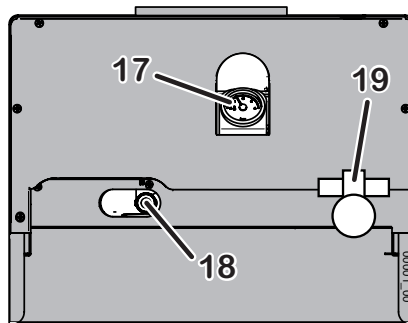

## Commands outside the boiler

Externally the boiler, suitably positioned in the building (generally by the installer or by the electrician), two devices that the user should access to, are present. The presence and the characteristics of these devices are prescribed by the regulation in force.

**Two-pole switch:** it is located usually close to the boiler and it's for electrically insulating the boiler itself from the domestic mains power supply network.

**Room thermostat:** it commands electrically the boiler to activate or deactivate the heating system, in order to keep the room temperature (detected by a sensor) within a value set by the user, Regulation in force prescribe its positioning, the temperature limits within the user can adjust it and the periods of heating. On trade are available programmable room thermostats: most of them allow to make a weekly programming of various temperature levels, besides special programs for various purposes. We suggest to choose original ITALTHERM accessories



# Typical use

## Preliminary operations

- ▶ Firstly, the knob **12** should be on the position  $\leftarrow \rightarrow 0$  **8**.
- ▶ Make sure, by the gauge **17** that the **cold-system temperature is always within 0.5 and 1.5 Bar (optimal: 1±1.5 Bar)**. When the pressure **drops below 0.5 Bar**, the boiler **stops working**. In this case, open the system filling cock **18** up to obtain, on the gauge, a **value between 1.0 and 1.5 Bar**.

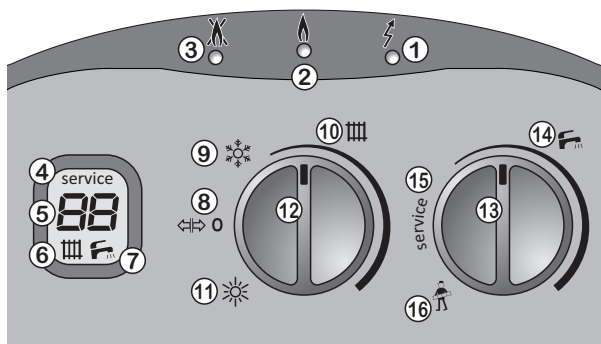

**(i)** The system pressure raises with the temperature: a too high initial cold-system pressure could lead to **water drain from the 3 Bar safety valve** after the system heating-up.

- ▶ Make sure that the gas cock **19** is open.
- ▶ Make sure that the boiler is electrically supplied: green light **1** blinks.

## Boiler activation

- ▶ Rotate the knob **12** on Summer  $\text{☀}$  **11** if you want to have only hot water production, or on Winter  $\text{❄}$  **9** if you need both room heating and hot water production.
- ▶ Opening a hot water cock, the burner ignites and, after a short time (that also depends on the characteristics of the plant externally the boiler) hot water flows from the cock.
- ▶ In Winter  $\text{❄}$  mode, consequently a request by the Room thermostat, the burner ignites and the produced heat is sent, by means of the system vector liquid, to the heating elements of the building. If, in the mean time, a Domestic Hot Water request takes place, this latter has the priority for the whole request time. Since the DHW requests are usually limited in time, they generally don't have any effect on the room heating.

## Temperature adjustment

**Note:** correct adjustment leads to creating the conditions for energy saving.

- ▶ **Heating system adjustment:** by rotating the knob **12** along the scale  $\text{||||}$  **10**, the setting of the heating system temperature is made (the value, during the adjustment, is shown on the display **5**). Generally, in the deep cold season and/or with poor building thermal insulation (or if you notice that the burner stays on for a long time, but the room temperature rises too slowly) prefer higher settings. On the contrary, if you notice that the room temperature exceeds too much, for thermal inertia, the value set on the room temperature, it's appropriate to decrease the system temperature.

**Note:** if the **Remote Control Kit** is installed, see also "Remote Control Kit" on page 39 and the relevant instruction booklet.

**Note:** don't make confusion between the heating system temperature  $\text{||||}$  here described, with the temperature of the room set on the Room Thermostat.

- ▶ **Domestic hot water adjustment:** by rotating the knob **13** along the scale **14**, the setting of the hot water produced by the boiler, is made (the value, during the adjustment, is shown on the display **5**). On this type of boiler, we suggest to set the knob in such a way to have a comfortable hot water temperature by drawing only hot water or eventually by mixing it with a little cold water. Avoid maximum values if not strictly needed, that will force to mix the hot water with bigger

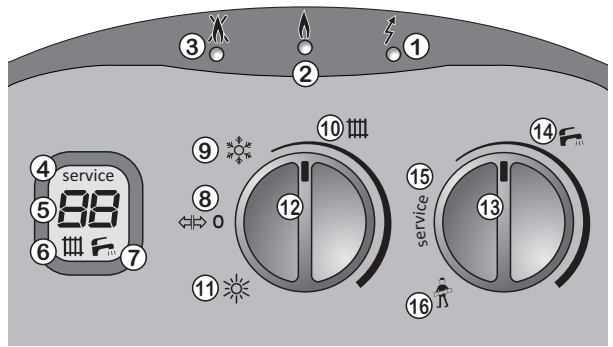

quantities of cold water. Consider that, because of the dispersions along the pipings, a certain time is needed to have a stable water temperature on the cock outlet, therefore the best temperature evaluation is achieved during a bath or a shower.

## Incidental malfunctioning



**Avoid performing personally any intervention that are job of the technician, for example the ones on the electrical circuits, on hydraulic system or on the gas system, and whatever other operation that's not mentioned in this "User Guide" section and expressly allowed to the User. Always address yourselves to qualified personnel.**

**Boilers must be always equipped with original accessories only.**

**ITALTHERM Srl is not responsible for damages caused by the incorrect, wrong or unreasonable use of not original materials.**

### *The burner doesn't turn on*

- ▶ if the room thermostat (or programmable room thermostat, or similar) is installed, check that it is really requiring the room heating;
- ▶ check that the electrical power supply is present and that the Summer/Winter **||||** knob isn't positioned on **⇄O** (stand-by) but on Summer **☀** or Winter **❄**. The **GREEN** light should be **steadily ON** (see details in the paragraph "The front control panel" on page 7);
- ▶ if the **RED** locking light was on or blinking, or if you notice an anomalous behaviour of the light indicators, see the paragraph "Alarms - boiler block" on page 30;
- ▶ check on the gauge that the boiler pressure is correct (**1÷1.5 Bar in a cold state**) or at least **not below 0.5 Bar**;
- ▶ let the technician to look up the notes in the paragraph "Electrical diagram" on page 37.

### *Shortage of domestic hot water production*

- ▶ check that knob **Fm** is not set on a too low value or to the "service" position
- ▶ call a qualified technician to check gas valve regulation;
- ▶ call a qualified technician to check, and eventually clean, the DHW exchanger.



Remark: where the water hardness value is too high, it is suggested the installation of a softening device, in order to prevent the limestone precipitation; this operation avoids a frequent cleaning of the coil.

## Boiler inactivity

The effects of the periods of inactivity can be relevant in particular situations such as in flats used only for some months per year, most of all in cold places.

The user will have to decide to put the boiler in the **SAFETY SHUT OFF state** disconnecting all the supplies, or to **leave it in stand-by and use the Anti Frost Function**. When there is the possibility of freezing it is convenient to chose between the advantages and the disadvantages of the SAFETY SHUT OFF and of the Stand By/Anti Freezing Way.

### *Safety shut off*

- ▶ Turn off the general switch on the Electrical Supply Line of the Boiler;
- ▶ Close the Gas Tap;

**(i)** When it is expected that the temperature is going to decrease under 0°C, call a technician to do the following:

- Fill the system with an anti-freezing solution (unless the system was already filled with said solution) otherwise it must be completely emptied. Notice that if it had been necessary to restore the pressure (because of possible loss) in an heating system already filled with an Anti freezing solution, the concentration of the solution could have decreased and it could not guarantee the Anti freezing Protection.
- completely empty the hot and cold sanitary water system, including the sanitary circuit and the boiler's sanitary exchanger.

**Remark:** *the boiler is equipped with a system which protects the main components from the exceptional cases of mechanical lock, due to the inactivity in presence of water and scale. The anti-locking function can't work in Safety shut off mode, because of the lack of electrical supply.*

**(i)** Before re-igniting the boiler, have a technician check that the pump is not blocked due to inactivity (for the technician: unscrew the plug in the centre of the cap to access the rotor shaft and turn it with a screwdriver or other suitable tool).

### *Stand-by mode with anti-frost & anti-locking function*

When the boiler is left in stand-by during a period of inactivity, it will be protected against freezing by several functions provided in the electronic controller, which heat the parts involved when the temperature falls below factory set values.

The anti-frost heating is accomplished by turning on the burner and pump.

In addition, when the boiler is in stand-by, it periodically activates the main internal components to avoid rare cases of blockage due to inactivity in the presence of water and lime. This can also occur when the boiler is locked (red lamp on) provided that the system pressure is correct.

In order for these systems to be active:

- the boiler must be receiving gas and electricity;
- boiler must be left in stand-by mode (Summer/Winter knob on  , **green** lamp flashing);
- system pressure must be correct (1±1.5 bar in a cold state, minimum 0.5 bar)

In case of lack of gas, the burner won't turn on and the boiler will go in LOCK OUT state (red lamp on or flashing). Nevertheless the pump will work, making the water circulate in the system and reducing in this way the possibility of freezing.

**(i)** ATTENTION: the anti-frost protections cannot intervene in the absence of electricity. If you anticipate this possibility, we recommend you add a good brand of anti-freeze to the heating system, following the producer's instructions.

**We recommend to ask directly the installer/technician about the type of antifreeze product put in the heating system during installation.**

When the power comes back on, the boiler will check the temperature measured by the two probes and, if it suspects freezing verified by a particular automatic control cycle, alarm 39 will be triggered. For more details, see the relative description in the paragraph "Alarms - boiler block" on page 30.

**(i)** We recommend that you completely empty the hot and cold sanitary water system, including the sanitary circuit and the boiler's sanitary exchanger. The anti-frost function does not protect the sanitary circuit outside the boiler.

### **"Ambient Anti-Frost" Function**

**Note:** if you want to use the "Ambient Anti-Frost" function that is often available in common room thermostats or chronothermostats, it is necessary to leave the boiler in Winter ❄️ mode and NOT in stand-by.

**(i)** The "Ambient Anti-Frost" function does not protect the sanitary circuit outside the boiler and, especially, in areas where the heating system doesn't reach. For this reason, we recommend that you empty the cold and hot sanitary water from the parts of the system that are at risk of freezing.



## **Installation**

### **Law and regulation prescriptions for the installer**

**Note for the translator/writer:** Place in this paragraph all the recommendations relevant to the compliance with laws in the destination nation/country (if any). As an example (from Italian regulation):

**Characteristics of the room:** as this boiler has an heat output lower than 35 kW (about 30000 Kcal/h), it is not required to install the appliance in a dedicated room, provided that the room complies with the regulation in force and that all installation rules assuring a safe and regular gas boiler operation, are strictly respected.



**Permanent ventilation of the installation room is mandatory and extremely important** when a boiler with air draught from the installation room (B... appliance type) is installed. Ventilation must be made and sized in compliance with Laws and Rules in force.

**Instructing the user:** at the end of the installation, the installer must:

- explain the operation of the boiler and its safety devices to the user;
- give this user this booklet and the documentation within his/her competence, duly filled in where required.

# Dimensions and connections

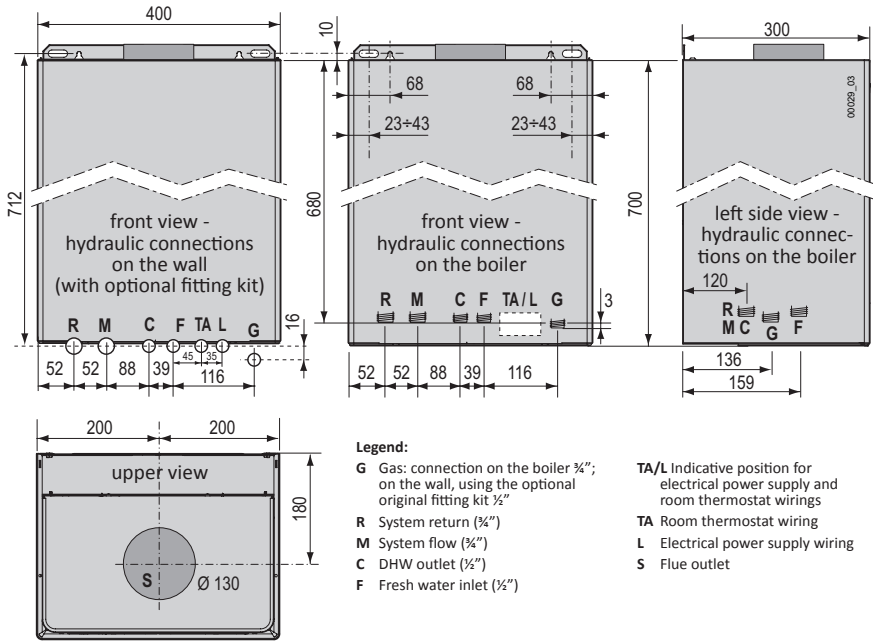

## Pump capacity diagram

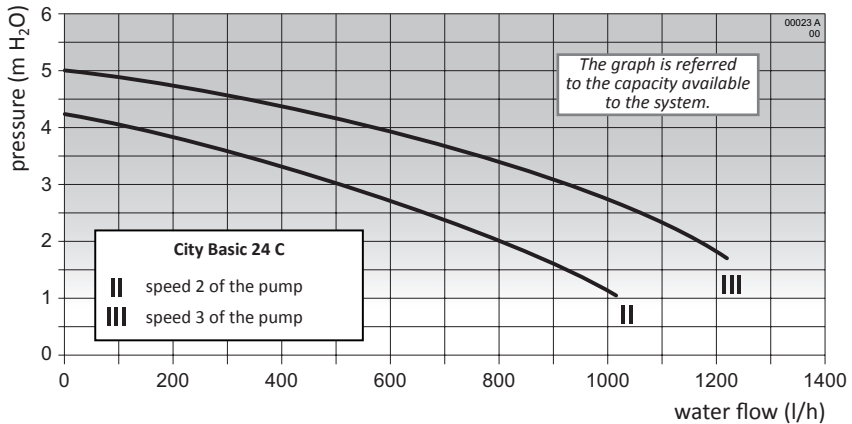

## Specifications for inlet air

Air must be withdrawn from places free of pollutant (like fluorine, chlorine, sulfur, ammonia, alkaline or similar agents). In the event of installation of the boiler in atmospheres with not negligible presence of aggressive chemical substances (e.g. hairdressing salons, laundries) we recommend to install a type C appliance, i.e. a forced draught and sealed chamber boiler, with air inlet from outdoor.

## Domestic water supply characteristics

**The cold water inlet pressure must be lower than 6 Bar.** Besides, for an optimal boiler functioning, water pressure **should be more than 1 Bar.** A lower pressure could make difficult to restore correctly the pressure the heating system, and reduce the flow of hot water available from the boiler.

**(i)** In case of higher pressure **it is indispensable to install a PRESSURE REDUCER** upstream the boiler.

**The cleaning frequency of the DHW heat exchanger depends on the water supply hardness.** If the water hardness is more than 25° fr it's required to install a softener to bring the hardness below that value.

Besides, the presence of solid residuals or impurities in the water (for example in case of new systems) could compromise the correct functioning of the boiler. For DHW production systems, the regulation in force prescribes a safety filter to protect the systems.

## Protection against freezing

Thanks to its antifreeze system, inner components could never reach a temperature lower than 5°C. This system is activated when the boiler is supplied by the electrical and gas lines, provided that the pressure in the heating system is correct.

**(i)** In case of boiler installation in rooms where temperature can drop down to 0°, it is advisable to fill the heating circuit with an antifreeze liquid specific for heating systems, propylenic glycol based, following the instructions of its manufacturer. Pay attention to the correct product concentration: adding those substances to the heating water in incorrect dose could lead to the deformation of the seals and cause unusual noises during operation.

ITALTHERM S.r.l. will not be held responsible for consequent damages.

**Instruct the User about the antifreeze function of the boiler and about the antifreeze product added in the heating system.**

## Positioning and fastening

**(i)** This type B boiler, with open chamber and natural draught, is not suitable for outdoor installation, neither in a partially protected place.

If necessary, the open hooks can be positioned at any point along the edge **B** of the boiler's frame bracket, provided that they are 2 and that they support the device in a correct and safe way.

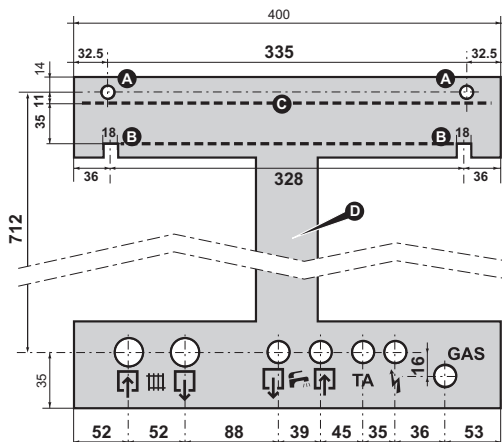
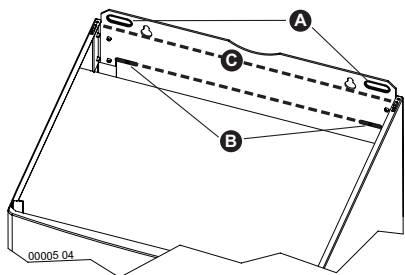

**Remark:** A re-usable metal jig (**D** in the figure) can be ordered separately, so as to facilitate connections and fixing points positioning (when the original connection kit is used). **If the metal jig and/or the original connection kit are not used, refer to the paragraph "Dimensions and connections" on page 13 for the position of the connections directly on the boiler.**

- ▶ Locate the exact position of the boiler considering the sufficient clearances for maintenance and servicing: at least 50mm laterally and 300 mm on the lower side
- ▶ To fix the boiler with wallplugs ("stud" type with nut), centre the relevant wall holes as regards to **A** points. To hang it with open hooks, place hooks in correspondence with **B** points.
- ▶ If the metal jig is used, hang it on the wall using the same wallplugs or hooks and the holes or slots indicated in the figure (**A** for the plugs and **B** for the open hooks).
- ▶ Fix up the connections and all ducts for heating flow and return, cold water, hot water, gas and electrical cables, predisposing them in the holes of the metal jig or respecting the measures in the paragraph "Dimensions and connections" on page 13. The upper edge of boiler's body is represented by the dotted line **C** in the figure.
- ▶ Remove the jig (if used) and hang the boiler to the wallplugs or hooks, using the holes or slots indicated in the figure (**A** for the plugs and **B** for the open hooks).
- ▶ **Remove the plastic caps** placed to close the hydraulic connections on the boiler.
- ▶ Proceed with the hydraulic, gas, electrical and flue connections following the instructions and warnings reported in the following paragraphs.

<b>GAS</b>	Gas (1/2")
	Hot Water Outlet (1/2")
	Cold Water Inlet (1/2")
	Heating Flow (3/4")
	Heating Return (3/4")
	Electrical Power Supply
<b>TA</b>	Room Thermostat

**(i)** The connections of the boiler are engineered to fit plain couplings with screw ring, interposing a plain gasket of suitable size and material, that ensure a reliable seal even without excessive tightening force. They are NOT suitable for hemp, teflon tape or similar materials

**Remark:** the lower grid is spare inside packing, not assembled. We suggest to fix the grid only at the end of the boiler installation operations.

## Hydraulic system (DHW and heating)



Make sure that the hydraulic and heating systems ducts **are not used as earth connections of the electrical system**. They are absolutely NOT SUITABLE for such a use. Besides: they don't guarantee the earth dispersion; in case of electrical fault they could generate a fulguration risk; there could take place galvanic currents in the pipings and consequent corrosion and hydraulic leaks.

### *Advices and suggestions to avoid vibrations and noises in the system*

- ▶ Do not use pipes with reduced diameters;
- ▶ Do not use bends with small radius and reductions of important sections.

### *Cleaning and preservation of the systems*

The efficiency, the reliability and the safety of the boilers, as all generic thermal systems and components, depend strictly on the features of the water that supply them and on their treatment.

A proper treatment of the water improves the protection of the systems against corrosions (and therefore perforations, noise, leaks, etc.) and limestone incrustations that drastically reduce the efficiency of the thermal exchange (consider that 1 mm of limestone incrustations reduces of 18% the thermal exchange of the heating element on which it has been formed).

ITALTHERM guarantees its products only if the characteristics of the water comply with UNI 8065, reported also in laws on energy saving.

**(i)** Thoroughly wash the heating system with water, before connecting the boiler. This will eliminate residual like welding drops, slag, hemp, mastic, mud, rust and other dirt from pipes and radiators. Otherwise, these substances could enter the boiler and damage the internal components (pump etc.).

- ▶ **In case of old or very dirty systems, to wash them use specific, proven efficiency products**, in the suitable quantity and following the instructions of its manufacturer.
- ▶ If the water on boiler inlet is harder than 25° fr, it's required to install a softener to bring the hardness below that value, as required by the reference regulation.
- ▶ For floor system and generally all low temperature systems, the water treatment product must have filming action (protection against corrosion and incrustation) and action against bacteria and algae.

### *Heating system*

- ▶ Connect the safety evacuation ducts of the boiler to an evacuation funnel. If safety valves are not connected to an evacuation device, their intervention could flood the room. The manufacturer cannot be held responsible for any damage arising from that situation.

## Heating system filling and pressuring

Once all system connections have been carried out, proceed with system filling. This operation should be made with care, respecting the following steps:

- ▶ Open the radiators venting devices;
- ▶ Check that the plug of the automatic air vent, incorporated in the boiler circulator, is unscrewed: if not, unscrew it and leave it unscrewed, even afterwards, for normal operation;
- ▶ If it's required to fill the system with anti-freeze solution, do this operation, then hermetically close the connection or the valve used to put the solution in, to allow the pressurization.
- ▶ Gradually open the filling cock 1 ;



- ▶ Check the correct functioning of automatic venting devices, eventually installed;
- ▶ Close the radiators venting devices as soon as water flows out of them;
- ▶ Make sure, by reading the pressure gauge **2**, that the pressure reaches the optimal value of **1.0 bar (max 1.5 bar)**;
- ▶ Close the water supply valve **1** and bleed each radiator again;
- ▶ Repeat the venting and pressurization operations until the air is completely purged from the system.

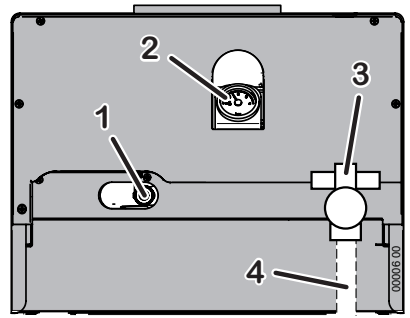

## Gas connection

Due to various installation possibilities, the gas cock **3** supplied with the original Connections Kit has a simple male  $\varnothing \frac{1}{2}$ " connection, facing the rear of the boiler. *The gas pipe **4**, upstream the gas cock **3**, should be supplied by the installer.*



**While connecting gas inlet pipe of the boiler to the pipe coming from gas network, it is MANDATORY to insert a PLAIN GASKET, whose dimensions and material must be adequate. Connection is NOT suitable for hemp, teflon strip or similar materials. Because of the type of fitting, the use of those materials does not make the suitable seal with consequent gas leaks!**



**Using LPG, it is absolutely necessary to install a pressure reducer upstream the boiler. Failure to do this, the gas valve of the boiler will get damaged.**



The gas connection, as generally the boiler installation, must be done by qualified personnel as prescribed by the regulation in force, because a faulty gas connection could lead to fire, explosion and other very serious damages to persons, animals and objects. The manufacturer cannot be held responsible for any damage arising from that situation.

### ▶ Verify what follows:

- cleaning of all system gas pipes in order to avoid the presence of work residuals that could compromise the correct boiler functioning;
  - gas line and ramp conformity with laws and rules currently in force;
  - internal and external tightness of the gas system and connections;
  - supply pipe must have a section greater than or equal to the boiler one;
  - supply gas must correspond to the one for which the boiler has been set: otherwise, it's mandatory to ask to qualified personnel to set the boiler for the correct gas type;
  - an interception valve must be installed upstream the appliance.
- ▶ Open the meter valve and purge the air that is inside the system pipes (including all the appliances).

## Electrical connections



The link of the room thermostat works with a safety extra low voltage (SELV); connect it to the voltage free contacts of the room thermostat/chronothermostat. **On NO account must any electrical voltage be applied** to these terminals.



All low-voltage wirings (e.g. Room Thermostat or Chronothermostat for trade) must be kept separate from power supply cables, as to avoid boiler malfunctioning due to electrical noise. It is advisable to use separate tubes for them.

The boiler must be connected to a 220÷240V - 50Hz electrical power supply. In any case, the power supply voltage must be within the range -15% ... +10% from the nominal value (230V); otherwise it may cause malfunctions or failures. It is necessary to respect the polarities L-N (Live L=brown; - Neutral N=blue) - otherwise the boiler may not work - and the earth connection (yellow-green cable).



**Place upstream the boiler a bipolar switch** in compliance with the regulation currently in force. The installation must be made complying the regulation currently in force and generally with the standard craft rules.

For the general electrical supply of the appliance the bipolar switch should be used. The use of adaptors, multiple taps and extensions is not allowed.

If the supply cable must be replaced, use one of the following cable types: H05VVf or H05-VVH2-F. **It is mandatory the earth connection in accordance with the rules actually in force.** To replace the cable, open the control panel cover, unlock its fastening device and disconnect it from the terminals. Install the new cable proceeding in the reverse way. When connecting the cable to the boiler, it's mandatory:

- to leave the Earth wire about 2 cm longer than the other (Live and Neutral) wires;
- to lock the cable upstream the terminals by means of the suitable fastening device.



Electrical safety of the appliance is only achieved when it is well connected to an efficient earthing system, executed as indicated by the safety rules actually in force.

A qualified technician must check that the electrical system is in line with the maximum power allowed by the boiler, indicated on the data plate, with particular attention to the cables section.



ITALTHERM S.r.l. declines any responsibility for damages to persons, animals or things caused by the faulty or missing connection of the boiler earthing and by failure to comply with the rules.

## Chimney connections

Carefully follow the prescriptions by the National and Local Regulation in force.

Indications to connect the duct to the chimney (except of different prescriptions by National or Local Regulation):

- ▶ Don't lean the flue pipe into the chimney, but stop it before the inner surface of the chimney. The axis of the flue pipe must intersect the axis of the chimney or of the flue duct.
- ▶ On the boiler flue outlet, there must be a vertical flue pipe which length must be at least two times the diameter of the pipe itself, measured on the pipe connection on the boiler.
- ▶ After the vertical length, the pipe must have a minimum upwards slope of 5% and a maximum length of 2500 mm.
- ▶ The boiler has been tested with a 1 meter chimney length.
- ▶ To calculate the chimney dimensions, refer to the Flue Mass Flow Rate and to the Flue Temperature data (see "Technical data" on page 34).

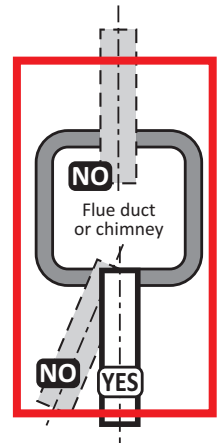
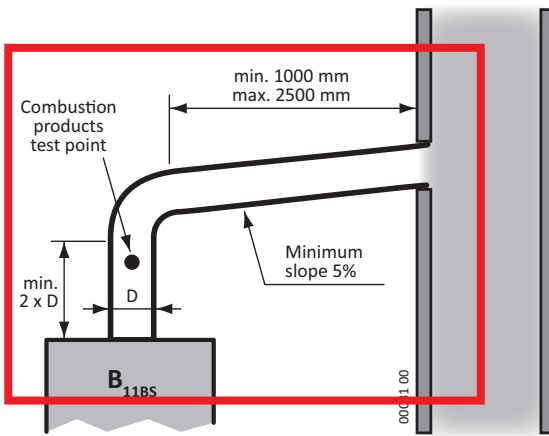

Model	Diameter <b>D</b> of the flue pipe
City Basic 24 C	130 mm



The boiler is fitted with a safety thermostat for the flue flow detection, that triggers when the combustion products reflow into the room. **This device must never be bypassed or put out of order.** Combustion products could lead to intoxication, permanent damage and death. **If the flue thermostat must be replaced, use the original spare part only.**

In case of repeated interventions of the device (and consequent boiler locks), check that the air supply / room ventilation system and the Flue Products Outlet System are efficient and made according to the laws in force.

**After whatever servicing of the flue thermostat, perform a functional test of the device itself (by momentarily obstructing the flue outlet duct).**

In case of flue outlet on wall, the positions and the distances prescribed by the regulation must be respected (see "Flue terminals positioning" on page 20).

## Flue terminals positioning

Posizionamento dei terminali di tiraggio (nella parete stessa di cui si sta valutando la zona di rispetto) per apparecchi a tiraggio naturale in funzione della loro portata termica  
(per informazioni dettagliate, vedere la norma UNI 7129-3:2008 e successive modifiche o integrazioni)

Posizionamento del terminale	Quota	Distanze minime (mm)		
		Apparecchi da 4 kW fino a 7 kW	Apparecchi oltre 7 kW fino a 16 kW	Apparecchi oltre 16 kW fino a 35 kW
Sotto finestra	A1	1000 ***)	1500	2500
Adiacenza ad una finestra	A2	400	400	400
Sotto ad una apertura di aerazione/ventilazione	B1	1000 ****)	1500	2500
Adiacenza ad una apertura di aeraz./ventilaz.	B2	600	600	600
Distanza in verticale tra due terminali di tiraggio	C1	500	1500	2500
Adiacenza in orizzontale ad un terminale di tiraggio	C2	300	500	600
Sotto balcone *)	D1	300	400	500
Fianco balcone	D2	1000	1500	1000
Dal suolo o da altro piano di calpestio	E	1000 **)	1500 ****)	2200
Da tubazioni o scarichi verticali od orizzontali	F	300	300	300
Sotto gronda	G	800	400	500
Da un angolo/mentelatura/parete dell'edificio	H	500	500	600

\*) I terminali sotto un balcone praticabile, devono essere collocati in posizione tale che il percorso dei fumi, dal punto di uscita del terminale al loro sbocco dal perimetro esterno del balcone, compresa l'altezza dell'eventuale parapetto di protezione (se chiusa, non sia minore di 2000 mm. Per una corretta computazione del percorso dei fumi vedere la norma UNI 7129-3:2008.

\*\*\*) Nella collocazione dei terminali devono essere adottate distanze non minori di 500 mm da materiali sensibili all'azione dei prodotti della combustione (per esempio, gronde e pluviali di materia plastica, elementi sporgenti di legno, ecc.); per distanze minori adottare adeguate schermature nei riguardi di detti materiali.

\*\*\*\*) Riducibili a 400 mm per apparecchi da riscaldamento installati sotto il vano finestra del locale riscaldato.

\*\*\*\*\*) In questi casi i terminali devono essere opportunamente protetti per evitare eventuali contatti diretti con persone.

Nota: Non è consentito scaricare a parete con terminale collocato all'interno di un balcone chiuso su 5 lati (vedere la norma UNI 7129-3:2008).







# Adjustment and Maintenance



**ATTENTION:** the operations described below must be carried out only by qualified personnel [authorized by ITALTHERM].



**When regulation/measuring is over, remember to tighten pressure tapping point screws and ALWAYS check for gas leaks!**



Before boiler ignition, **verify that pump is not blocked** due to its inactivity: **unscrew the plug** located in the middle of the cap **to gain access to the rotor shaft**, and **turn** it manually using a screwdriver or another suitable tool.



During the first ignition of the brand **new boiler**, it is necessary that **burner works for at least 30 minutes, before performing combustion checks**. During this time, the fumes of the eventual residual manufacturing materials are produced, and they could alter the measured values.

*Remark: during the first 10 minutes of electrical power supply, the re-ignition delay is nil.*

*Remark: the knob  on control panel has the position "service" that is used during the regulation of the MAX heating power (as described in this Section) and also during factory test (not described). For information purposes only, we explain that, further to a request of domestic hot water, this position activates the gas boiler at the minimum output set for this function.*

## First starting up

All boilers are tested and factory set during manufacture; however it is advisable, during the first starting up, to perform the following checks and, only if necessary, the adjustments that could be necessary.

1. check the inlet gas pressure and flow (see "Inlet gas check" on page 23);
2. check the burner pressure at maximum and minimum power input and gas valve adjustment (see "Max and Min pressure adjustment" on page 23);
3. adjust the max power output in heating mode (see "Max heating power adjustment" on page 24);
4. eventual customization of the electronic settings to adapt the boiler work to particular system requirements (see "Electronic settings" on page 26).

## Access to the inside of the boiler

1. Unscrew the screws **1** and remove the lower grid **2**, if any;

*Remark: Lower grid is spare inside packing, not assembled.*

2. Push the casing **3** upwards and remove it;
3. unscrew the two screws **4** and overturn downwards the control panel **5**;
4. after the regulations, close the boiler repeating everything in the other sense, carefully hooking the casing **3** to the tongues **6**.

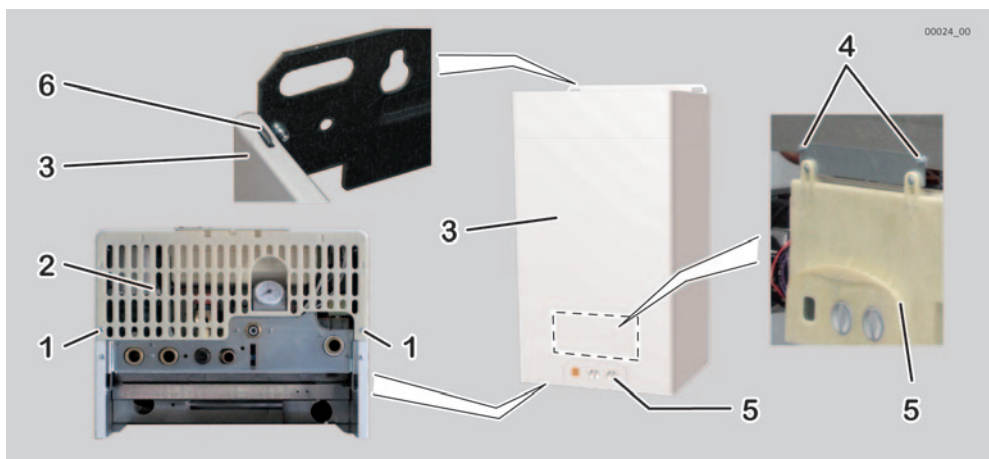







## Inlet gas check

**Remark:** The pressure should be measured at nominal input, so this test must be performed with the burner ignited.

- Loosen (2-3 turns) the screw of pressure tapping point 2 of the gas valve and insert the manometer sensor;
- check that the measured pressure complies with the inlet gas nominal pressure (see "Technical data" on page 34).
- close the pressure tapping point 2 and check the absence of gas leaks.

## Max and Min pressure adjustment

- Loosen (2-3 turns) the screw of pressure tapping point for gas outlet 1 of the gas valve and insert the manometer sensor. Do not use the tapping point "Vent" 3 that **must always be closed**;
- Activate the boiler to its maximum output not modulated, using the "Chimney-sweeper" function. Proceed as follows:
  - supply the boiler and turn the Summer/Winter knob  to Summer position ;
  - provide that Room Thermostat contact is closed (activated) or open an hot water tap (the heat produced by the boiler will be drained consequently);
  - turn the Hot Water knob  to the position Chimney-sweeper  and wait (about 5 seconds) that the display shows "SE" (SErvice) flashing (moreover, **GREEN** lamp flashes with short lightnings).
  - when the display shows "SE" flashing, turn the Hot Water knob  on the scale . On the display, the indication **service** appears and the burner ignites at the maximum output not modulated (the **YELLOW** indicator turns on);

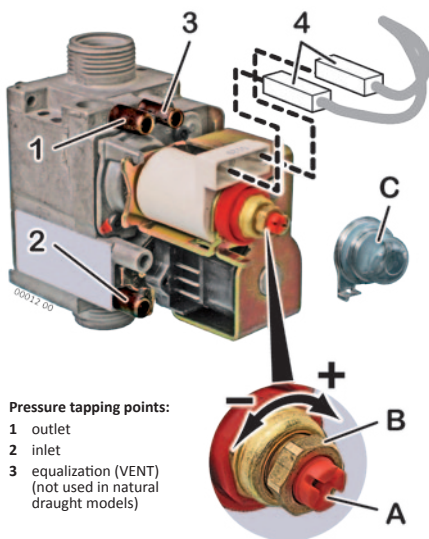

3. **wait at least 10 seconds** and verify that the measured pressure corresponds to the MAX value indicated in the Burner Pressure table (see page 26), with regard to the boiler model and gas type;
4. extract one of the connectors **4** that supply the modulation coil; verify that the measured pressure corresponds to the MIN value indicated in the Burner Pressure table (see page 26), with regard to the boiler model and gas type;
5. reinsert the connector **4** ;
6. if it is necessary to adjust the regulation, proceed as it follows, referring to the figure:
  - take off the protection cap **C** ;
  - adjust MAX pressure acting on the nut **B** (10 mm). Turn clockwise to increase pressure, counterclockwise to decrease pressure;
  - extract again one of the connectors **4** ;
  - adjust MIN pressure acting on the screw **A** (with a 4 mm screwdriver), paying attention not to temporarily move the nut **B** . Turn clockwise to increase pressure, counterclockwise to decrease pressure;
  - reinsert the connector **4** and check that MAX pressure is not changed;

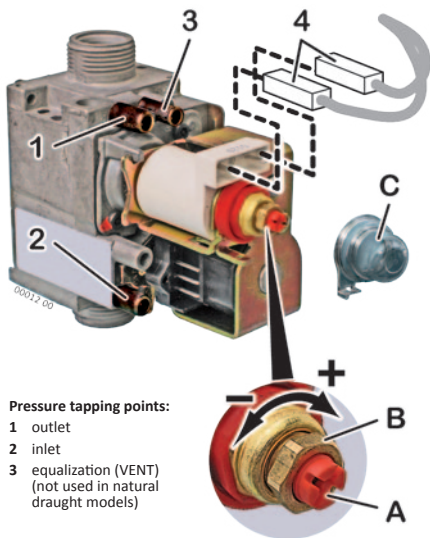

**Important: LOCK THE ADJUSTMENT DEVICE AFTER ANY SETTING OPERATION.**

- mount the cap **C** ;
7. screw the pressure tapping point screw for gas outlet **1** and **verify that there is no gas leak**.
  8. To switch the burner off, turn the Summer/Winter knob to the position.





## Max heating power adjustment

The maximum heating power output must be set in accordance with the system requirements (stated in the project). Once you know the power suitable for the heating system, refer to the "Burner pressure tables" on page 26 and find the burner pressure for the boiler model and for the type of gas used.



The adjustment will be performed through the boiler's controls, following a special procedure that avoids accidental activations by the User:

1. Loosen (2-3 turns) the screw of pressure tapping point for gas outlet **1** of the gas valve and insert the manometer sensor. Do not use the tapping point "Vent" **3** that **must always be closed**;
2. supply the boiler and turn the Summer/Winter knob to Summer position ;
3. ensure that there are NOT domestic hot water requests (no open taps); if the room thermostat is installed, make so that it requires the heating (e.g. raise the requested room temperature manually);
  - turn the Hot Water knob on **service** position: on the display will appear a flashing number from 00 to 99 that indicates the current set point of the value of heating power, where the value **00** corresponds to the minimum setting of the gas valve and the value **99** corresponds to the maximum;
  - wait (approximately five seconds) that the display shows "**PO**" (POver) flashing (moreover, both the **GREEN** and **RED** indicators flash to short "pulses").





- when the display shows “PO” flashing, within 15 seconds turn the Summer/Winter  knob on the MAXIMUM value of the scale of the heating  (fully clockwise). The **service** indication appears on the display and the burner ignites to the maximum output not modulated (the **YELLOW** indicator turns on);
- read on the micromanometer the value of the gas pressure to the burner and turn the Summer/Winter  knob along the heating system temperature scale  , until you read, on the micromanometer, the burner pressure corresponding to the power needed; the display will show a flashing number from **00** to **99** indicating the new set point;





**Remark:** the value from 00 to 99 that appears on the display during the setting, is foreseen to be read at the end of the adjustment and to be eventually re-used as a quick reference to set the boiler again to the same heating power. To set the power the first time, make exclusively reference to the burner pressure measured by the micromanometer.

- **do NOT move the Summer/Winter  knob for about 30 seconds**, until the number on the display stops flashing (also the **GREEN** indicator stops flashing and stays on). During this time, **check that the pressure displayed on the manometer remains stabilized** on the correct value. If further pressure adjustment should be needed, turn the knob and wait again 30 seconds and the end of flashing;
- to confirm and save the setting, turn the Hot Water knob  on the scale  ; the burner will turn off for a moment. Wait (about 5 seconds) that both the **GREEN** and **RED** indicators stay on for about 5 seconds (this is the confirmation that the burner pressure for heating is stored), then the **RED** indicator turns off;

4. screw the pressure tapping point screw for gas outlet **1**; **verify that there is no gas leak.**

5. To switch off the burner, turn the Summer/Winter knob  to the  position.

The MAX power for the heating system is adjusted now.

The whole procedure should be completed within 15 minutes from the start. If you exceed this time, or in case of mistakes, the new pressure will not be stored and it will be necessary to repeat the procedure from the beginning, by turning the Summer/Winter knob  on  and the Hot Water knob  on the scale  .

# Burner pressure tables

**Note:** the max heating power adjustment is allowed only in boilers classified as "range rated".

	HEAT OUTPUT		Display value	NATURAL GAS G20		BUTANE G30		PROPANE G31	
	kW	kcal/h		mbar	mm H <sub>2</sub> O	mbar	mm H <sub>2</sub> O	mbar	mm H <sub>2</sub> O
<b>City Basic 24 C</b>	MIN. 8.8	7568	00	2.2	22	4.8	49	4.8	49
	10	8600		2.7	28	5.9	60	6.0	61
	11	9460	↓	3.2	33	7.1	72	7.3	75
	12	10320	↓	3.8	39	8.3	85	8.8	89
	13	11180		4.4	45	9.7	99	10.4	106
	14	12040	↓	5.1	52	11.1	113	12.1	124
	15	12900		5.7	59	12.7	129	14.0	143
	16	13760	↓	6.5	66	14.3	145	16.1	164
	17	14620		7.2	74	15.9	163	18.3	187
	18	15480	↓	8.0	81	17.7	181	20.7	211
	19	16340		8.8	90	19.5	199	23.2	237
	20	17200	↓	9.6	98	21.5	219	25.9	264
	21	18060		10.5	107	23.4	239	28.8	294
	22	18920	↓	11.4	116	25.5	260	31.9	325
MAX. 23.0	19780	99	12.3	125	27.5	281	35.0	357	

## Soft ignition

Soft ignition pressure is automatic and it needs no adjustment.

- The ignition is achieved by means of a burst of electrical sparks, while the burner is supplied with gas, initially to the MIN pressure set on the valve gas, then pressure increases gradually (soft ignition ramp) until the ignition takes place.
- The flame is detected by the flame detection electrode. When the flame is detected, the spark burst stops, the soft ignition process terminates and the burner will be supplied with the gas pressure corresponding to the power required by the function in progress (domestic hot water or heating).

## Electronic settings

### Accessing the main board

To access the main board:



**Cut off the electrical supply to the boiler.** Restore the supply after having closed the control panel rear cover.

- ▶ unscrew the screws **1** and remove the back cover of the control panel.

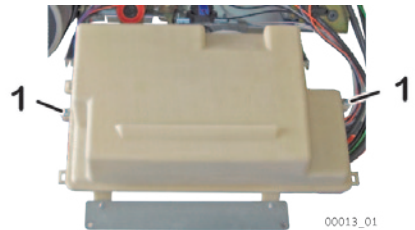

00013\_01

## Main board settings

The boiler is equipped with a Microprocessor modulation board, featuring a 6-microswitch array (SW1÷SW6) which allow to make personalizing actions for the boiler's functioning as described in the following table.



**Disconnect the power supply** before approaching the microswitches. Restore the power supply only after you have closed the back cover of the control panel.



Changes to microswitches status have no effect until the boiler is electrically supplied (they are red during the board startup, when the supply is connected).

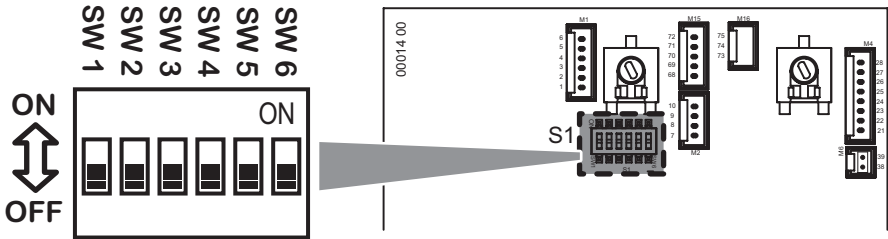

**SW1** OFF Natural gas Functioning.

ON Butane (G30) or Propane (G31) Functioning.

The factory setting depends on the gas type arranged in factory for the boiler. To change the type of gas supply, it is necessary to follow the complete instructions described in the paragraph "Gas conversion" on page 28.

**SW2** OFF In City Basic Boilers it must be OFF. **Factory setting.**

**SW3** It determines the delay of 3 minutes, before the new ignition of the burner after the overcoming of the heating set temperature.

OFF delay ON (for normal radiators systems). **Factory setting.**

ON delay OFF (for fan coil systems).

**SW4** OFF In City Basic Boilers it must be OFF. **Factory setting.**

**SW5** Pump functioning mode during heating working.

OFF **intermittent** for normal applications (with or without delay, see SW3). **Factory setting.**

**always off** (external pumps are present).

ON *Remark: The pump will be anyway activated in all other circumstances, e.g. during the DHW functioning, for post-circulation (if foreseen) or for anti-freezing or anti-lockout functions.*

**SW6** OFF In City Basic Boilers it must be OFF. **Factory setting.**

## Gas conversion



**ATTENTION:** the operations described below must be carried out only by qualified personnel [authorized by ITALTHERM S.r.l.].

For gas conversion, use the nozzles supplied by boiler manufacturer only.



Using LPG, it is absolutely necessary to install a suitable pressure reducer upstream the boiler.

1. Disconnect the boiler from the electrical supply. Remove the boiler cover as described in the paragraph "Access to the inside of the boiler" on page 22.
2. Access the main board and switch **SW1** (see also "Main board settings" on page 27) accordingly with the available gas type:
  - **OFF** for **Natural gas (G20)**,
  - **ON** for **Butane (G30)** or **Propane (G31)**
3. Ensure that the inlet gas pressure complies with the required nominal pressure (see "Technical data" on page 34) and that the gas flow is sufficient to guarantee the appliance correct work.
4. Remove the pipe between the gas valve and the injectors bar.
5. Remove injectors bar and replace the nozzles\* with the ones suitable for the available gas type, using a 7 mm. spanner (see figure). The nozzles number and diameter is stated in the table "Technical data" on page 34.
6. Reassemble injectors bar and pipe, replacing gaskets. Check, with burner ON, that there are no gas leaks;

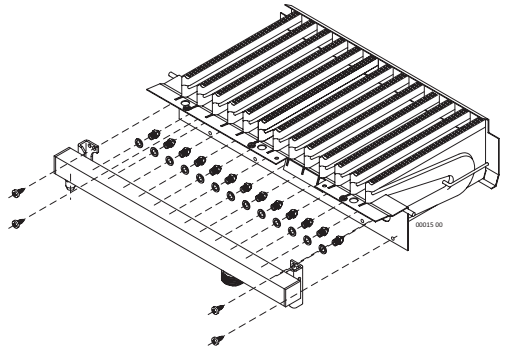









\* Install the nozzles kit with the supplied washers, although the existing nozzles, factory fitted in the boiler, are originally without washer.

7. Verify, with burner ignited, the inlet gas pressure (see page 23).
8. Check and if necessary adjust the gas valve maximum and minimum pressure (see page 23) and the heating maximum power (see page 24).
9. **Check that there are no gas leaks.**
10. Apply the sticker indicating the type of gas (supplied with the kit) on the suitable area on "WARNING" label inside the boiler.

# Combustion check

The boiler has the “chimney-sweeper” function, forcing burner ignition at the maximum output not modulated. This function allows more reliable measurements of those obtained when the gas boiler is activated through the room thermostat or hot water demands.

- ▶ Prepare the instruments for combustion checking;
- ▶ activate the “chimney-sweeper” function, following this simple procedure, studied to avoid accidental activations of the user;
  - supply the boiler and turn the Summer/Winter knob  to Summer position ;
  - provide that room thermostat contact is closed (activated) or open an hot water tap (the heat produced by the boiler will be drained consequently);
  - turn the Hot Water knob  to the position Chimney-sweeper  and wait (about 5 seconds) that the display shows “SE” (SErvice) flashing (moreover, **GREEN** lamp flashes with short pulses);
  - when the display shows “SE” flashing, turn the Hot Water knob  on the scale . The indication **service** appears on the display and the burner ignites at the maximum output not modulated (the **YELLOW** light turns on);
- ▶ make the checks and measurements;
- ▶ switch off the burner, by turning the Summer/Winter knob  to the  position. The **GREEN** light blinks.

*Remark: the burner will switch off automatically when reaching the maximum temperature, and in any case after 15 minutes.*

## Hydraulic settings (pump speed)

The pump has a selector which allows to reduce the speed, so as to reduce the noise produced by the too rapid circulation of the liquids in too small heating systems.

- **III = Maximum Speed** (Factory setting)
- **II = Medium Speed**
- **I = Minimum Speed** (use only if strictly necessary; test the heating system, verifying that no overheating problems occur).

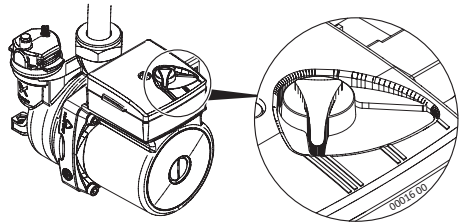

## Draining the heating system

When it is necessary to drain the heating system, proceed as described here below:

- ▶ Connect a rubber pipe to the draining tap terminal **1** ;
- ▶ put the other end of the pipe in a suitable drain or sink;
- ▶ open the draining tap by turning the nut **2** counter-clockwise, using a suitable spanner;
- ▶ when the pressure is COMPLETELY drained, it's possible to open the radiators venting valves, to allow the air inlet. The complete system drain is possible only draining the liquid from the lowest point of the system itself.
- ▶ when everything is over, close taps (turning the nut **2** clockwise) and air vents.

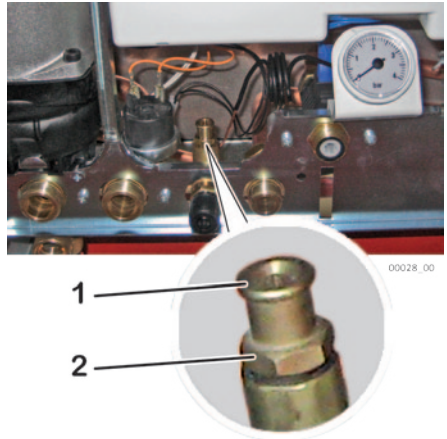

**(i)** In the primary exchanger a certain quantity of water of the heating system remains. If you want to remove the boiler from the wall, we advise you to close with plugs the hydraulic inlet/outlet heating system connections.













## Alarms - boiler block











Following a malfunction, the boiler can lock-up and show a particular signalling, consisting of an alarm code on the display and of the status of the **RED** light indicator (and eventually of the **GREEN** and the **YELLOW** ones). In the following table, all the alarm signals are listed, their most probable causes and the suggested solutions.

Each alarm code is complete of the status of the **RED** light indicator: = on; = blinking; = flashing with pulses; = off. Some alarms are signalled with a combination of two or more lights, in this case the light colours are explicitly reported close to the relevant status.

















**Operations accompanied by the symbol are always reserved to the Technician. Operations with grey background are reserved to the Technician.**

Signal	Probable causes	Suggested solutions
<b>01</b> 	Boiler just installed (air mixed to gas).	Retry the ignition several times: turn the knob  on the unlock position  , wait the red light to turn off, then bring the knob in the previous position.
	The flame has extinguished or it did not ignite	Restore the boiler function by turning the knob  on the unlock position  , wait the red light to turn off, then bring the knob in the previous position.
	Incorrect electrical power supply	In case of frequent blocks, verify the correct combustion, the good state and the cleaning of the burner.  Ensure that the Live, Neutral and Earth connections are correct and efficient and in particular that the Live and Neutral are not swapped (see "Electrical diagram" on page 37).
		<i>Remark: The problem could also be caused by an incorrect distribution of electricity on the network (neutral unbalanced).</i>

Signal	Probable causes	Suggested solutions
02 	the boiler has overheated and the Safety Thermostat has triggered	Turn the knob  on the unlock  position until the red lamp turns off (or eventually for a longer period to make the boiler cool), then then bring the knob in the previous position. If necessary, wait and try again for few times. If the lockout persists or reappears, call the Service Centre.   Verify the safety thermostat functionality. Detect the causes of the overheating, e.g. an insufficient circulation in the primary circuit; max gas pressure out of the limits or maximum heating power excessive for the heating system size.
03 	Incorrect flue flow (even momentary)	Restore the boiler function by turning the knob  on the unlock position  , wait the red light to turn off, then bring the knob in the previous position. If the lockout persists or reappears, call the Service Centre.   check the efficiency of the flue ducts and of the flue flow detection device.
	Insufficient air supply / room ventilation	Check that the outlet which communicates with the outdoor, compulsory according to the regulation in force, is not obstructed by pieces of furniture against the wall or by other objects. <i>It is however normal that the outlet is realized behind a radiator.</i> The outlet must be of the dimension prescribed by the law and must be cleaned inside: some types have an anti-insects net which could have been dirtied by dust or by spider webs. Call a Qualified Technician when it is necessary.
	Interferences with air supply / room ventilation	If in the room where the boiler is installed there are fireplaces, stoves, coal stoves or similar, fans for the air outlet, such as wall fans, aspiring cowls for cooking boards with outlet pipe, let the technician check that the inlet is correctly OVERSIZED or that there are the ADDITIONAL inlets as prescribed by the laws in force, because, otherwise, these devices interfere with the evacuation of the boiler flue.
- 5	Communication between display and main PCB is not correct	At every Power On, this alarm is showed for max 2-3 seconds; then it will disappear. If not, call the Service.   Check display, main PCB and connection wire. Replace what it is needed.
05  	Failure to the system flow temperature probe.	Check the cabling of the system flow temperature probe. Replacement of the system flow temperature probe.
06  	Failure to the DHW temperature probe.	Check the cabling of the DHW temperature probe. Replacement of the DHW temperature probe.

Signal	Probable causes	Suggested solutions
<b>10</b> 	Insufficient system pressure <i>(loss of water pressure switch triggered)</i>	Restore the correct pressure as described in "Preliminary operations" on page 9 or (preferably by the Technician) in "Heating system filling and pressuring" on page 16.  <i>Remark: Consider that the pressure, in normal conditions, should not decrease with the progress of the time. If this happens, there is probably a loss in the heating system. Sometimes the loss is so small that it doesn't leave evident signs, but with the progress of the time it can cause the decreasing of the pressure. Also the opening of the manual venting taps of radiators (intentional or unintentional) makes the pressure decrease. Check that this doesn't happen.</i>
<b>22</b> 	Memory-stored data not coherent.	<b>User:</b> Disconnect the electrical supply to the boiler by operating the suitable external bipolar switch, then connect it again after a few minutes. If the lockout persists or reappears, call the Service Centre.  Redo all the boiler settings ("Max heating power adjustment" on page 24 and "Electronic settings" on page 26) to update the data in the main board memory.  Replace the main board (consequently, redo the "Max heating power adjustment" on page 24 and "Electronic settings" on page 26).
<b>31</b>	This alarm is described in paragraph "Remote Control Kit" on page 39.	
<b>33-34</b> 	Cabling configuration error.	Refer to the electric diagram (page 37) and check the integrity of the wirings, especially the eventual short cable jumpers between two contacts of the same connector (on the cabling connections to the electronic board).
<b>35</b>  <b>RED</b>   <b>YELLOW</b> 	Unexpected flame the control electronic has detected the flame on the burner when this one should be off	Wait for the boiler automatic reset (5 minutes) or reset it manually by turning the knob  on the unlock position  , waiting the red light to turn off, then bringing the knob in the previous position. If the lockout persists or reappears, call the Service Centre   Detect eventual malfunctioning of the gas valve (that does not stop fully the gas flow, so the burner remains ignited) or of the electronics, flame detection section (that detects the flame presence even if it's absent).
<b>39</b> 	Suspected freezing  After a power failure, the boiler detected temperatures at the Heating and DHW probes equal to, or less than, 0°C when power was restored	The display shows the alarm code 39 while the boiler inhibits the ignition of the burner and activates the circulator, forcing water to circulate in the hydraulic circuits.  If, during this time, the temperatures measured by the probes rise above +1°C, the alarm is reset and the boiler returns to the normal operation.  Otherwise, the alarm will persist and you should suspect that water has frozen at one or more points of the hydraulic circuit of the boiler and/or system (with possible damage to the frozen parts). If the alarm persists, call a qualified technician.   Find/replace the parts damaged by the freezing.



Signal	Probable causes	Suggested solutions
42  RED  YELLOW 	System error Anomaly of inner boiler device(s) Mains electrical power supply out of tolerance limits	Detect the fault or anomaly also referring to the technical literature reserved to the service centres.
-- (??) 	The "Hot Water" knob  is on a position reserved to the technician:  or <b>service</b> .	Turn the knob back along the scale  .
-- (??) RED  GREEN 	it has been started, by mistake (moreover very improbable), a procedure reserved to the Technician	In order to avoid malfunctions, do the following as soon as possible: <ul style="list-style-type: none"> <li>▶ turn the knob  on the off/unlock  position;</li> <li>▶ turn the "Hot Water" knob  along the scale  ;</li> <li>▶ turn the knob  on the normal working position (Summer  or Winter  along the scale ).</li> </ul>

## Warnings for servicing



All servicing operations and gas conversions **MUST BE CARRIED OUT BY QUALIFIED TECHNICIANS**, in compliance with the norms and laws in force (see an indicative list on page 4). Moreover, **MAINTENANCE** operations must be carried out in compliance with the manufacturer prescriptions and with the laws and rules presently in force, for the parts not mentioned in this handbook.



**Natural draught "C" models must be subjected to maintenance at least once a year.**

**A careful servicing is always a guarantee of safety and energy saving.** Normally, it will be necessary to execute the following operations:

- ▶ Remove any possible oxidization from burners and electrodes;
- ▶ Remove the scale from the exchangers;
- ▶ Check integrity and stability of the ceramic fibre coverings in the combustion chamber and proceed eventually to substitution;
- ▶ Check the boiler ignition, switching off and operation;
- ▶ Check the water and gas connections tightness;
- ▶ Check the gas consumption at the minimum and maximum output;
- ▶ Verify that safety devices are correctly working;
- ▶ Verify the correct functioning of control and adjusting devices;
- ▶ Verify the correct functioning and the integrity of the flue system and of the relevant terminals and accessories
- ▶ In case of works or servicing of the structures placed near the above mentioned ducts and /or devices and their accessories, switch off the boiler;
- ▶ Do not leave any inflammable tanks and/or substances in the installation room;

- ▶ If the boiler draws directly from the installation room (*type B appliance installed indoor*): Do not clean the room where boiler is installed, while it is working
- ▶ Clean casing with soapy water only. Do not clean casing, other painted or plastic surfaces with thinner.
- ▶ In any case of parts replacement, it is mandatory to use ITALTHERM original spare parts.

**ITALTHERM declines any responsibility in case of non-original spare parts utilization.**

**"Once all check and servicing operations have been carried out, the technician must write a report for the user, who must countersign a copy for receipt and vision" as prescribed by the regulation in force.**

## Technical data

TECHNICAL DATA	Gas type	U.M.	City Basic 24 C	
			G20	G30 / G31

CE certification			0694 CM 3400	
Class			II <sub>2H3+</sub>	
Type			B11/BS	

Max heat input	kW	25.7	25.7
Min heat input	kW	9.9	9.9
Max heat output	kW	23.1	23.1
Min heat output	kW	8.6	8.6
NO <sub>x</sub> Class		2	1 / 1
CO at 0% O <sub>2</sub> (Qn)	ppm	54.4	124 / 60.3
CO <sub>2</sub> at nominal input	%	4.3	5.4 / 5.0
Flue temperature (Qn)	°C	101	101 / 101
Flue mass flow rate (Qn)	kg/h	86.6	79.1 / 85.0

### EFFICIENCY

Nominal efficiency	%	90.0
Efficiency at 30% load	%	89.1

### HEATING

Temperature selection range (min÷max)	°C	35÷78
Expansion vessel	l	8
Expansion vessel pre-loading pressure	bar	1
Loss of water pressure switch off / on pressure	bar	0.5 / 0.9 (±0.2)
		<i>To allow the correct system filling, the pressure of the domestic water should be higher than the ON value of the pressure switch.</i>
Max working pressure	bar	3
Max system temperature	°C	83

(follows)

TECHNICAL DATA (cont'd)	U.M.	City Basic 24 C	
		G20	G30 / G31
Gas type			

### HOT WATER

Flow rate at 25°C temp. rise	l/min	13.3
Flow rate at 30°C temp. rise	l/min	11.1
Min water flow (for the DHW function activation)	l/min	2.2
Min supply pressure (for the DHW function activation)	bar	0.5
Max supply pressure	bar	6
Temperature selection range (min÷max)	°C	30÷55

### ELECTRICAL DATA

Voltage / frequency (nominal voltage)	V / Hz	220÷240 / 50 (230V)
Power consumption	W	110
Level of protection		IP X4D

### DIMENSIONS

Width - Height - Depth	mm	see "Dimensions and connections" on page 13
Weight	kg	29

### CONNECTIONS

Hydraulic and gas connections		see "Dimensions and connections" on page 13
Flue: types, lengths and diameters		see "Chimney connections" on page 18

### GAS SUPPLY PRESSURE

Nominal pressure	mbar	20	29 / 37
Inlet pressure (min÷max)	mbar	17 ÷ 25	28÷30 (G30) 35÷40 (G31)
Injectors number		12	12
Injectors diameter	mm/100	125	77 / 77

### GAS CONSUMPTION

Qmax	m³/h	2.72	
	kg/h		2.02 / 1.99
Qmin	m³/h	1.09	
	kg/h		0.81 / 0.80

**Note:** data have been measured with minimum length flue outlet duct (1 meter; see "Chimney connections" on page 18).

# Boiler internal components

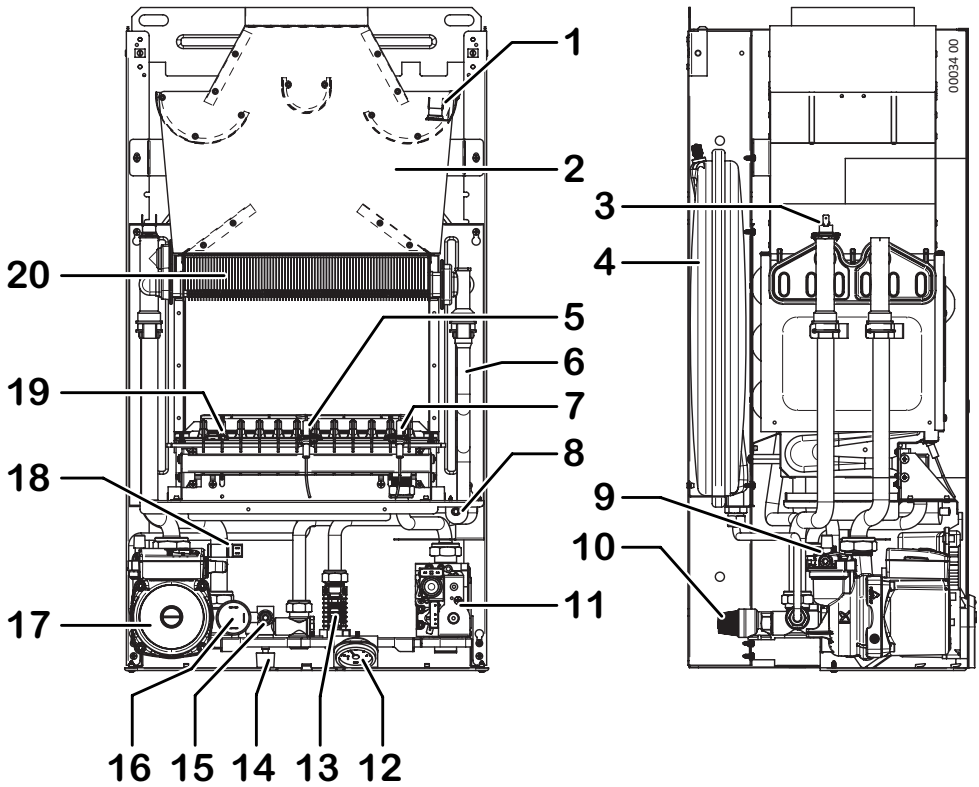

- |    |   |    |                                    |
|----|---|----|------------------------------------|
| 1  | Flue thermostat                                     | 11 | Gas valve                          |
| 2  | Flue hood   | 12 | System pressure gauge              |
| 3  | Safety thermostat for max. water temperature        | 13 | Priority flow switch (with filter) |
| 4  | Expansion vessel                                    | 14 | Filling valve                      |
| 5  | Ignition electrode                                  | 15 | Drain valve                        |
| 6  | DHW temperature sensor                              | 16 | Loss of water pressure switch      |
| 7  | Flame sense electrode                               | 17 | Pump                               |
| 8  | Electronic igniter                                  | 18 | Heating circuit temperature sensor |
| 9  | Automatic venting device (incorporated in the pump) | 19 | Burner                             |
| 10 | Safety valve 3 bar                                  | 20 | Bithermic exchanger                |

# Electrical diagram

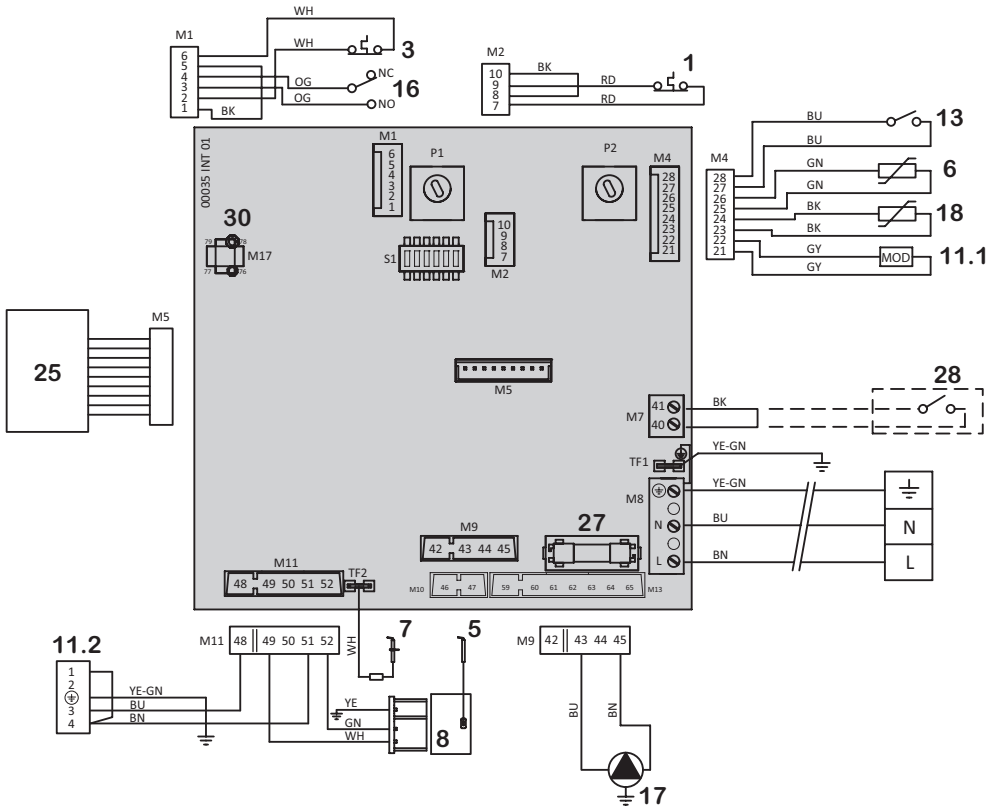

- 1 Flue thermostat (\*)
- 3 Safety thermostat for max. water temperature (\*)
- 5 Ignition electrode
- 6 DHW temperature sensor
- 7 Flame sense electrode
- 8 Electronic igniter
- 11.1 Gas valve - modulation control
- 11.2 Gas valve - opening control
- 13 Priority flow switch (\*)
- 16 Loss of water pressure switch (\*)
- 17 Pump
- 18 Heating circuit temperature sensor
- 25 Display board
- 27 Fuse F2A (2A fast)

## Optional external devices:

**28 Room thermostat:** Voltage-free Contact for Room Thermostat or Chronothermostat (for trade) working at safety extra low voltage SELV. Closed contact = heating request.

**Remote control:** Terminals of the original remote control device. See also page 39. To install, remove the jumper from the M7 terminals and connect the device to them.

**30 Connector for CH multi zones PCB kit**

## Abbreviations:

<b>BK</b> Black	<b>VT</b> Violet
<b>BN</b> Brown	<b>WH</b> White
<b>BU</b> Blue	<b>YE</b> Yellow
<b>GN</b> Green	<b>COM</b> Common
<b>GY</b> Grey	<b>NC</b> Normally closed
<b>OG</b> Orange	<b>NO</b> Normally open
<b>RD</b> Red	

(\*) the contacts of these components are shown in rest conditions (cold condition, no system pressure, no flow)

# Hydraulic diagram

**(i)** This diagram is for information only. To make boiler hydraulic connection either see "Dimensions and connections" on page 13 and eventually "Positioning and fastening" on page 14.

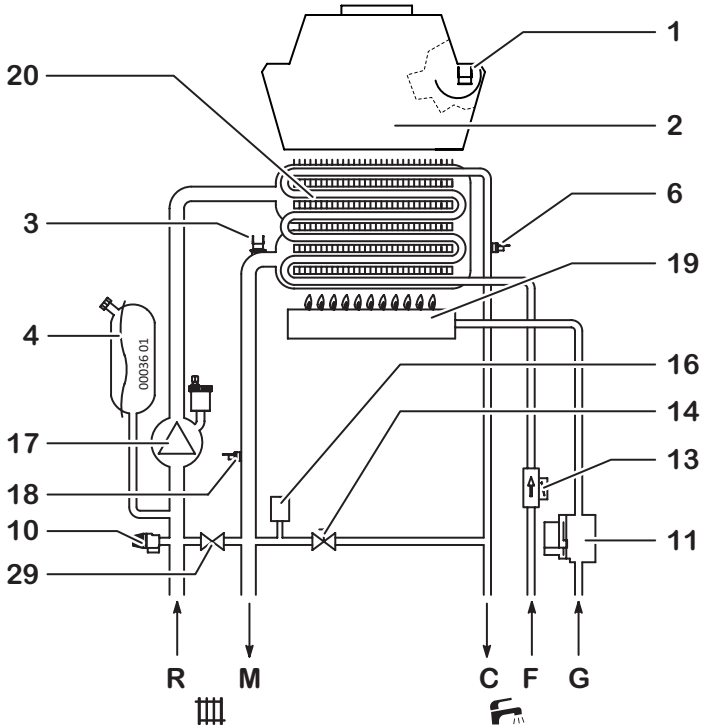

- |  |                                       |
|--|---------------------------------------|
| 1 Flue thermostat                              | 18 Heating circuit temperature sensor |
| 2 Flue hood                                    | 19 Burner                             |
| 3 Safety thermostat for max. water temperature | 20 Bithermic exchanger                |
| 4 Expansion vessel                             | 29 By-pass (automatic)                |
| 6 DHW temperature sensor                       | R Heating return                      |
| 10 Safety valve 3 bar                          | M Heating flow                        |
| 11 Gas valve                                   | C Hot water outlet                    |
| 13 Priority flow switch (with filter)          | F Cold water inlet                    |
| 14 Filling valve                               | G Gas inlet                           |
| 16 Loss of water pressure switch               |                                       |
| 17 Pump  |                                       |

# Remote Control Kit

This remote control is **more than a simple room thermostat**. Thanks to this, it is possible to **manage the boiler in all its settings** like DHW and CH temperature adjustment, **boiler reset** in case of boiler block, and of course it works as a **room thermostat** both in **manual** and **weekly program** mode. It's powered by the boiler (in safety low voltage), so **it doesn't need batteries**.



**(i)** Extract the Remote Control from its package. **Keep the relevant user instruction booklet and annex it to this Manual.**

**⚡** **Nor the Remote Control neither the relevant cable coming from the boiler must not, for any reason, be connected to the 230Vac supply mains.**



**(i)** To avoid malfunctions due to electrical noise, the Remote Control connections, as well as all low-voltage connections, should be kept separated from power supply cables, e.g. by enclosing it into separate raceways.





The maximum overall cable length shouldn't exceed 50 m.

1. Cut off electricity from boiler;
2. install the device as described in the **paragraph 4** of the supplied instruction booklet;
3. link the Remote Control wirings to the "Room Thermostat - Remote Control" cable coming out of the boiler, by means of a suitable bipolar terminal. See also "Electrical diagram" on page 37;

**Note:** *The Remote Control link is not polarized.*

4. power supply the boiler; **turn the boiler's Summer/Winter knob  on Summer  otherwise the Remote Control doesn't work** and the boiler goes into alarm **31** described below;
5. check the correct work of the device. The electronics should recognize it automatically.

**(i)** Hereafter, the Summer/Winter knob  should be left on Summer ; the boiler work is managed by the Remote Control, including the OFF, Summer and Winter modes, and the technical functions (such as several additional functions).

Signal	Probable causes	Suggested solutions
<b>31</b>	Communication error between the Remote Control (if present) and the boiler	<p>Disconnect the electrical supply to the boiler for 30 seconds by operating the suitable external bipolar switch, turn the boiler's Summer/Winter knob on Summer , then power supply the boiler.</p> <p>If the lockout persists or reappears, call the Service Centre. Under these conditions, <b>the boiler works only in DHW.</b></p>
<p><b>🔧 For the Technician:</b> Problems on the optional Remote Control connection link (passing close to supply cables or other electromagnetic field sources; connection failure; cable length over 50 meters).</p>		



[www.italtherm.it](http://www.italtherm.it)

**ITALTHERM Srl**

Via S. D'Acquisto, snc • 29010 Pontenure (PC) - IT  
Tel. +39.0523.575611 • Fax +39.0523.575600

[www.italtherm.it](http://www.italtherm.it) • e-mail: [info@italtherm.it](mailto:info@italtherm.it)



960000001\_08\_ENG - 05/03/2015

ITALTHERM Srl declines any responsibility for eventual printing and/or transcription errors in the present manual. In order to constantly improve its products, the company has the right to change features and data written in the present manual, at any time and without notice.



UNI EN ISO 9001:2008