

# BAXI

User's Operating Instructions &  
Important Warranty Information

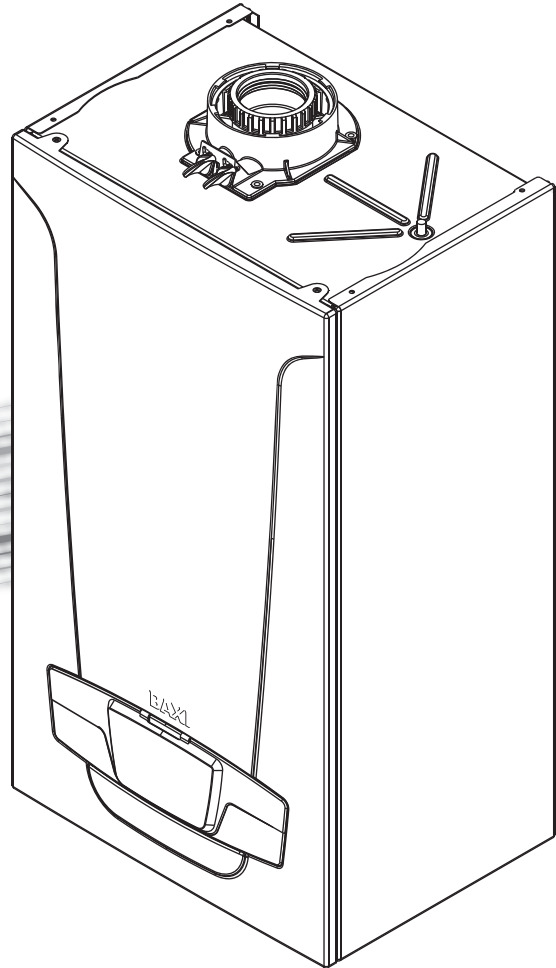

## Megaflo 2 System Compact GA Range

Gas Fired Wall Mounted Condensing  
System Boiler

Please keep these instructions in a safe place.  
If you move house, please hand them over to the next occupier.

## Model Range

Baxi Megaflo 2 System 12 Compact GA  
G.C.N° 41-075-70  
Baxi Megaflo 2 System 15 Compact GA  
G.C.N° 41-075-71  
Baxi Megaflo 2 System 18 Compact GA  
G.C.N° 41-075-72  
Baxi Megaflo 2 System 24 Compact GA  
G.C.N° 41-075-73  
Baxi Megaflo 2 System 28 Compact GA  
G.C.N° 41-075-74  
Baxi Megaflo 2 System 32 Compact GA  
G.C.N° 41-075-75

## Contents

Section	Page
1.0 Quick Reference Guide	3
2.0 Troubleshooting	4
3.0 Temperature Adjustment & Care of the Boiler	6
4.0 Repressurising System & 'Service Due'	7
5.0 Clearances	8
6.0 Error Codes	9
7.0 Legislation	10
8.0 Emergency	11
9.0 Warranty & Service	Back page

### The Benchmark Scheme

Baxi Heating UK Ltd is a licensed member of the Benchmark Scheme which aims to improve the standards of installation and commissioning of domestic heating and hot water systems in the UK and to encourage regular servicing to optimise safety, efficiency and performance.

Benchmark is managed and promoted by the Heating and Hotwater Industry Council. For more information visit [www.centralheating.co.uk](http://www.centralheating.co.uk)

© Baxi Heating UK Ltd 2013 All rights reserved. No part of this publication may be reproduced or transmitted in any form or by any means, or stored in any retrieval system of any nature (including in any database), in each case whether electronic, mechanical, recording or otherwise, without the prior written permission of the copyright owner, except for permitted fair dealing under Copyrights, Designs and Patents Act 1988.

Applications for the copyright owner's permission to reproduce or make other use of any part of this publication should be made, giving details of the proposed use, to the following address:

The Company Secretary, Baxi Heating UK Limited,  
Brooks House, Coventry Road, Warwick. CV34 4LL

Full acknowledgement of author and source must be given.

**WARNING:** Any person who does any unauthorised act in relation to a copyright work may be liable to criminal prosecution and civil claims for damages.

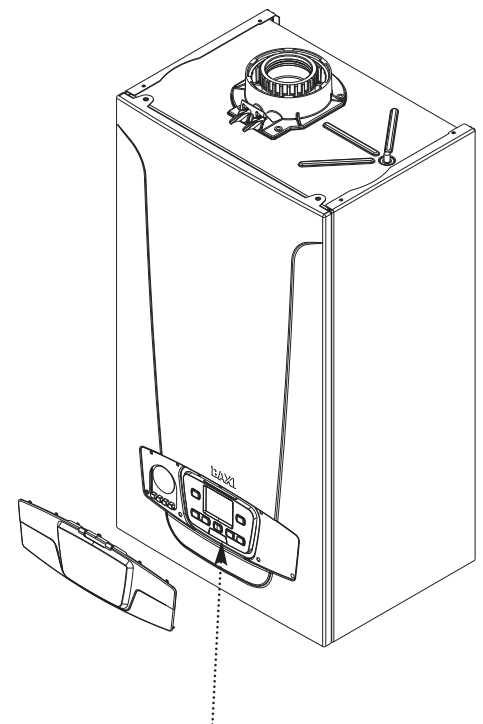

Boiler Controls - see opposite page for Operating Quick Reference Guide (Fascia Cover removed for clarity)



ISO 9001  
FM 00866

## 1.0 Quick Reference Guide

### Key to Controls

 Standby - Reset - Esc

 Boiler Information View

 Increase Boiler Temperature Button

 Decrease Boiler Temperature Button

 Inactive Button

 Inactive Button

 On/Off Selector Button

When  is displayed (Boiler On) the boiler will respond to timed Heating or Hot Water demand.

N.B. If only  is displayed the boiler will not operate !

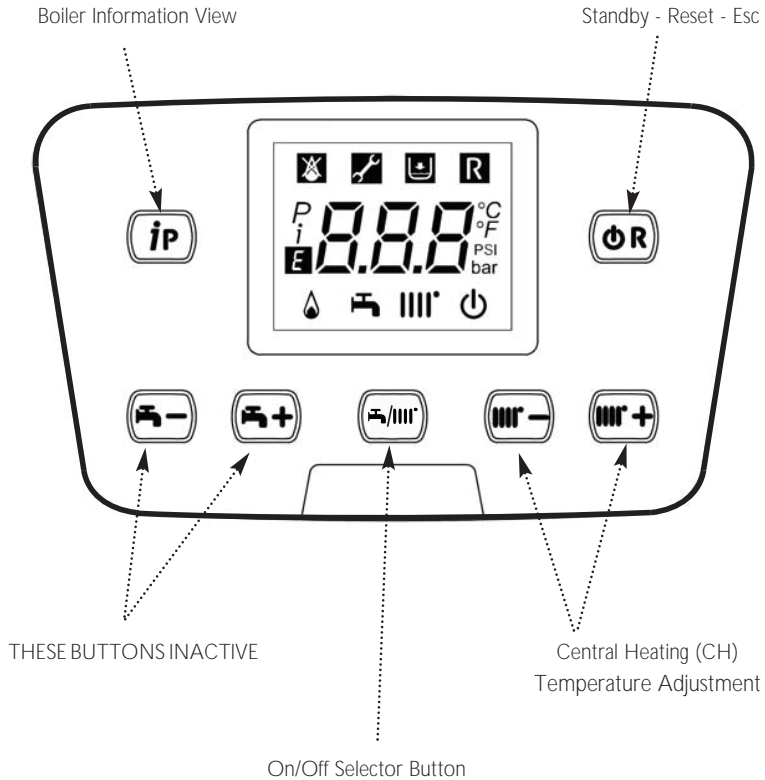

**NOTE:** When altering any settings it is necessary that the buttons are FIRMLY pressed for several seconds.

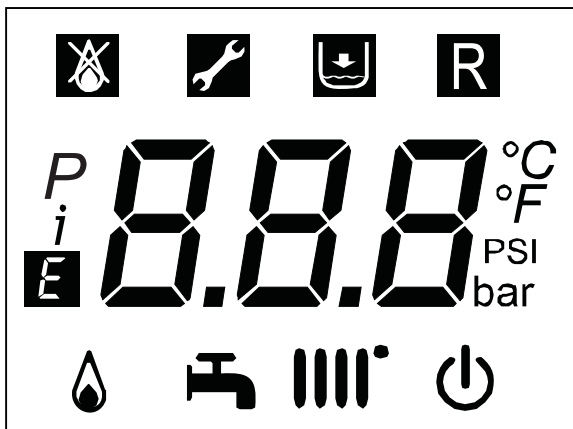



Display showing all available segments

### Display Description

 Boiler in Standby (frost protection still enabled)

 Indicate errors that prevent burner from starting

 Error - Not resettable by user

 Water pressure too low

 Indicates a resettable error

*P* Indicates navigation in programming mode (parameter)

*i* Indicates navigation in programming mode

 Generic error

 Burner lit

 Boiler on

*°C* Units for temperature

*°F*  
*PSI*  
*bar* Units for pressure

*5d* Service due

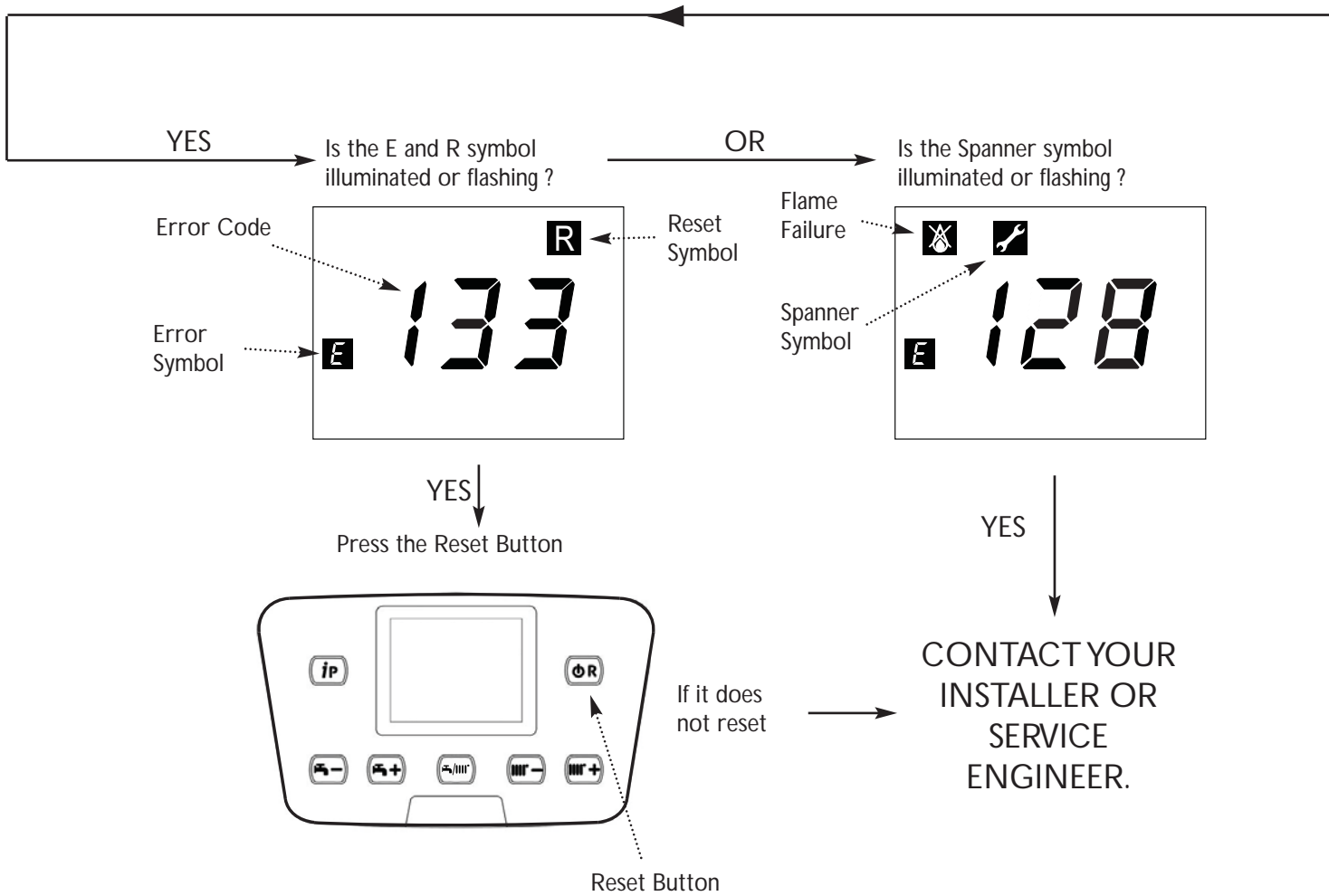
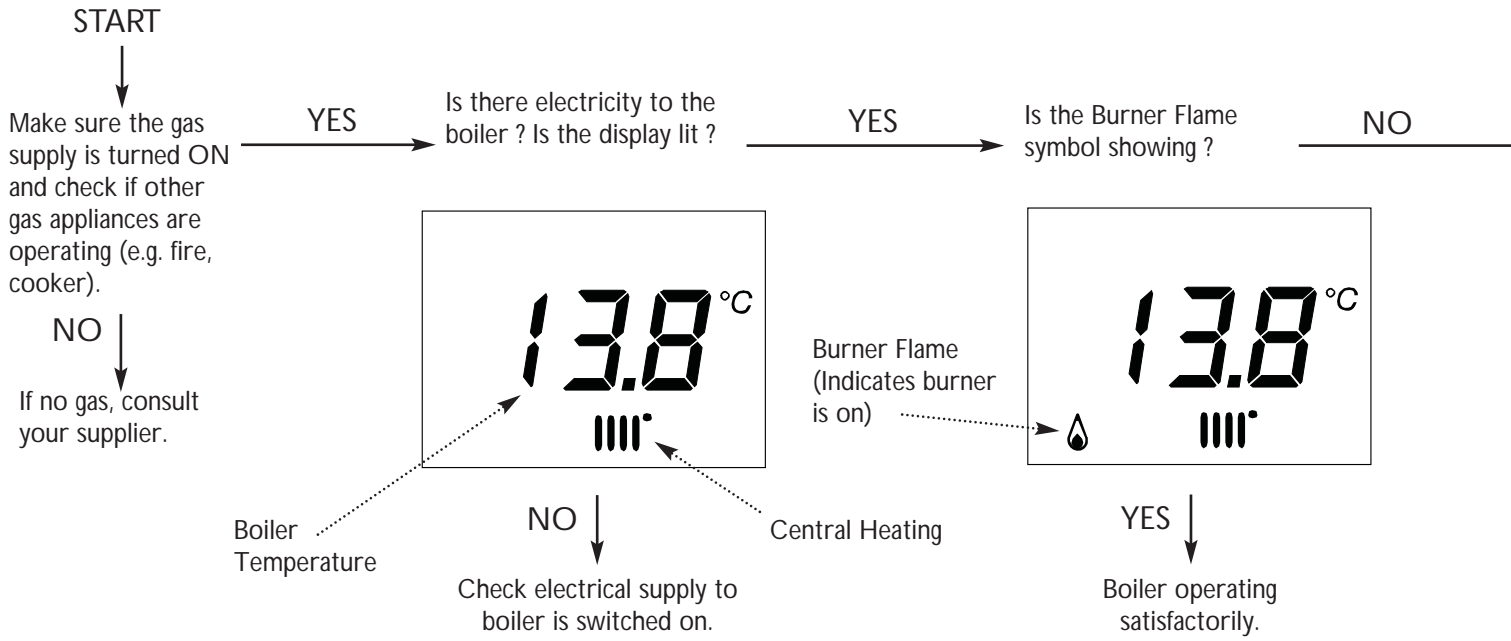

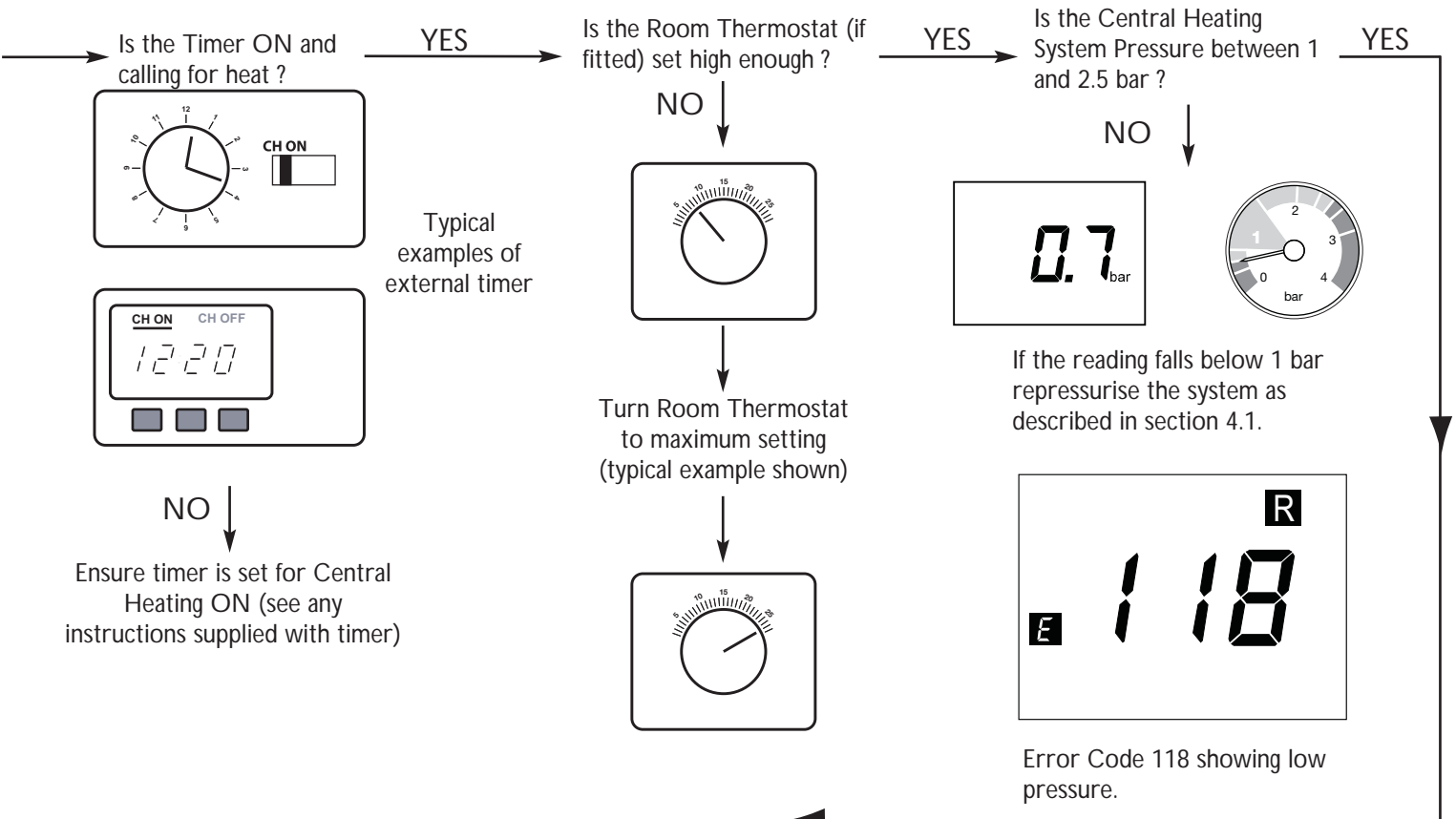

\*To display the water pressure press **IP** 6 times. '05' will alternate with the system pressure. (NOTE: When the pump is running the gauge under the boiler may show a slightly different reading to the display)

If you don't know what you need to do to get the boiler to light, or need help with the system and controls, contact your installer as soon as possible

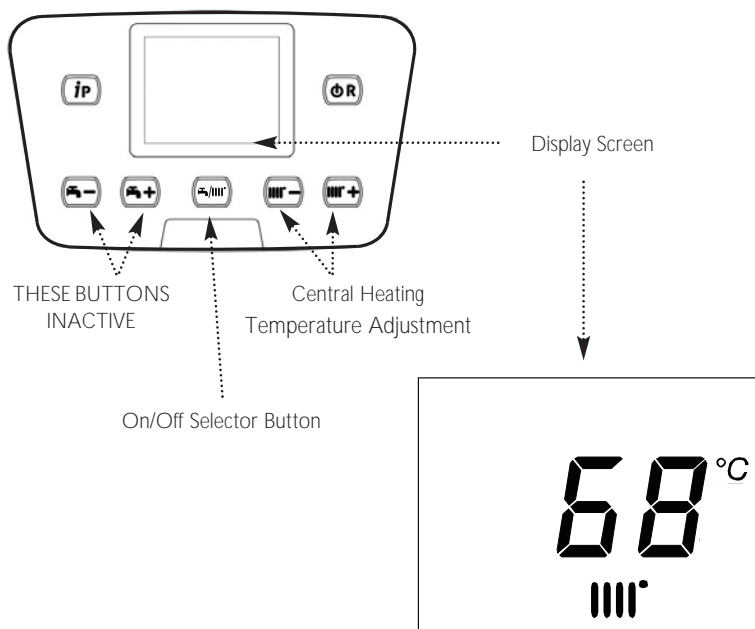

## 3.0 Temperature Adjustment & Care of the Boiler

### 3.1 To increase or decrease the boiler temperature

1. Press the ( ) to increase the boiler temperature.
2. Press the ( ) to decrease the boiler temperature.

**NOTE:** An overheat thermostat (NTC) is positioned in the heat exchanger which shuts down the appliance if the boiler temperature exceeds 100°C. Press button to re-establish normal operating conditions.

### 3.2 Boiler On Selector

1. Press the button until the Boiler On mode appears:-

### 3.3 Cleaning the Outer Case

The painted panels should be wiped with a damp cloth and then dried completely. **DO NOT USE ABRASIVE CLEANING AGENTS.**

### 3.4 Boiler Frost Protection

1. The boiler incorporates an integral frost protection feature that will operate when the boiler is on, and also when in standby ( displayed).
2. If the boiler temperature falls below 5° C., then the boiler will operate until the water temperature has been raised.
3. Further protection may be required for the system. Consult your installer for details.

### 3.5 Information Display

1. The table opposite shows information that can be displayed by pressing the *iP* button.
2. Press to return to the normal display.

The *iP* button can be pressed so that the display shows the following information:-

- 1 press - '00' alternates with Sub-Code (only when fault on boiler) or '000'
- 2 presses - '01' alternates with CH Flow Temperature
- 3 presses - '02' alternates with Outside Temperature (where Sensor fitted)
- 4 presses - '03' alternates with DHW Temperature
- 5 presses - '04' alternates with DHW Temperature
- 6 presses - '05' alternates with System Water Pressure
- 7 presses - '06' alternates with CH Return Temperature
- 8 presses - '07' alternates with Flue Temperature
- 9 presses - '08' alternates with Heat Exchanger Temperature

## 4.0 Repressuring System & 'Service Due'

### 4.1 Central Heating System Pressure

1. The normal operating water pressure is between 1 and 2.5 bar (Fig. 1). If the pressure exceeds 3 bar the safety pressure valve will operate and a fault is indicated (E117 displayed). Contact your installer.

2. It may be necessary to repressurise the system occasionally (as Fig. 2 or E118 displayed). A filling device (the filling loop) will be fitted on the system. This will be on the boiler itself, or on pipework near to the boiler.

3. If you are unsure of its position, or cannot identify it, consult the installer who fitted the boiler.

4. The filling loop consists of two taps and a separate copper pipe or braided hose with connection fittings.

5. Only when repressurising should the pipe or hose be connected between the two taps. Ensure that the nuts on the pipe or hose are tightened onto the taps.

6. Fully open one of the taps first, and then while watching the pressure gauge, carefully open the second tap.

7. The system pressure is shown at all times on the gauge under the boiler and can be viewed on the display when there is power to the boiler.

8. To display the water pressure press **iP** 6 times. '05' will alternate with the system pressure. (NOTE: When the pump is running the gauge under the boiler may show a slightly different reading to the display).

9. When the needle on the gauge or figures on the display indicate 1 or more turn both taps off.

10. Disconnect the pipe or hose from the taps (a small amount of water may be present) and remove it. Keep it in a safe place for future use.

### 4.2 'Service Due' Message

1. After 11 months operation the 'Service Due' message will be shown on the boiler display.

2. Please contact your Installer, Annual Service Provider or 'heateam' - The Service Division of Baxi to arrange your Annual Service. You can contact 'heateam' on telephone number 0844 8711 545 or visit [www.heateam.co.uk](http://www.heateam.co.uk)

Front and Side Panel removed for clarity

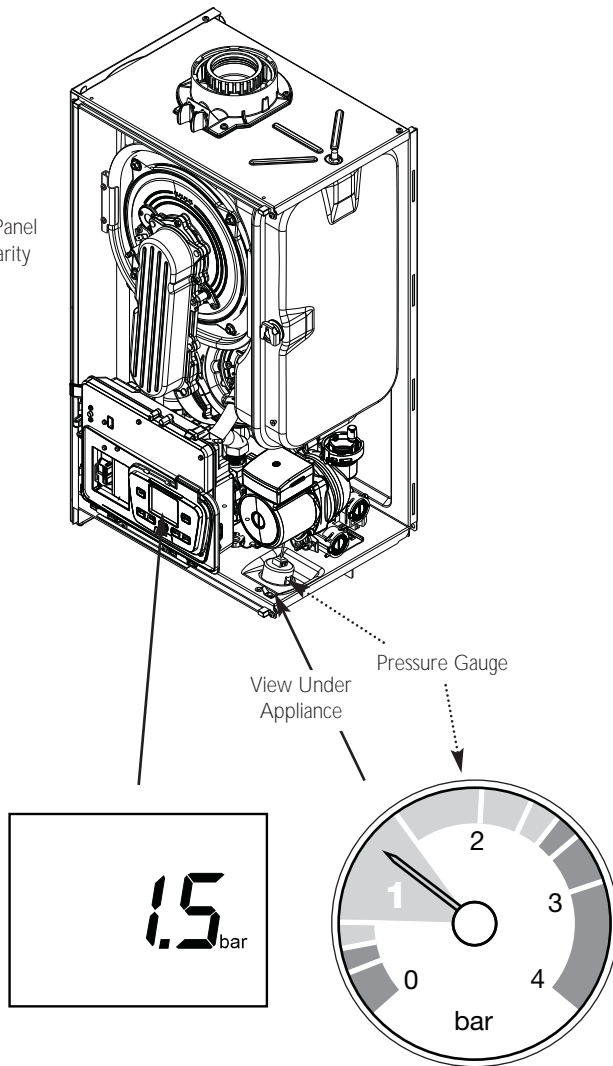
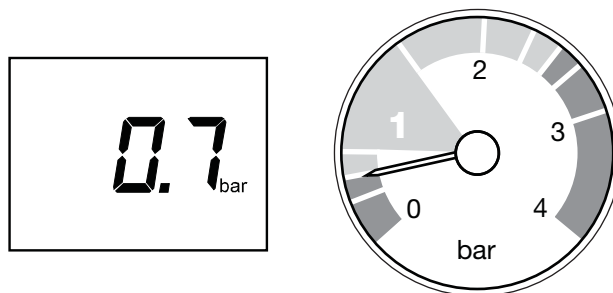

Fig. 1

Normal Pressure

Fig. 2



Requires  
Repressuring

'Service Due'  
Message  
'Sd' will show for  
three seconds,  
alternating with the  
boiler temperature.



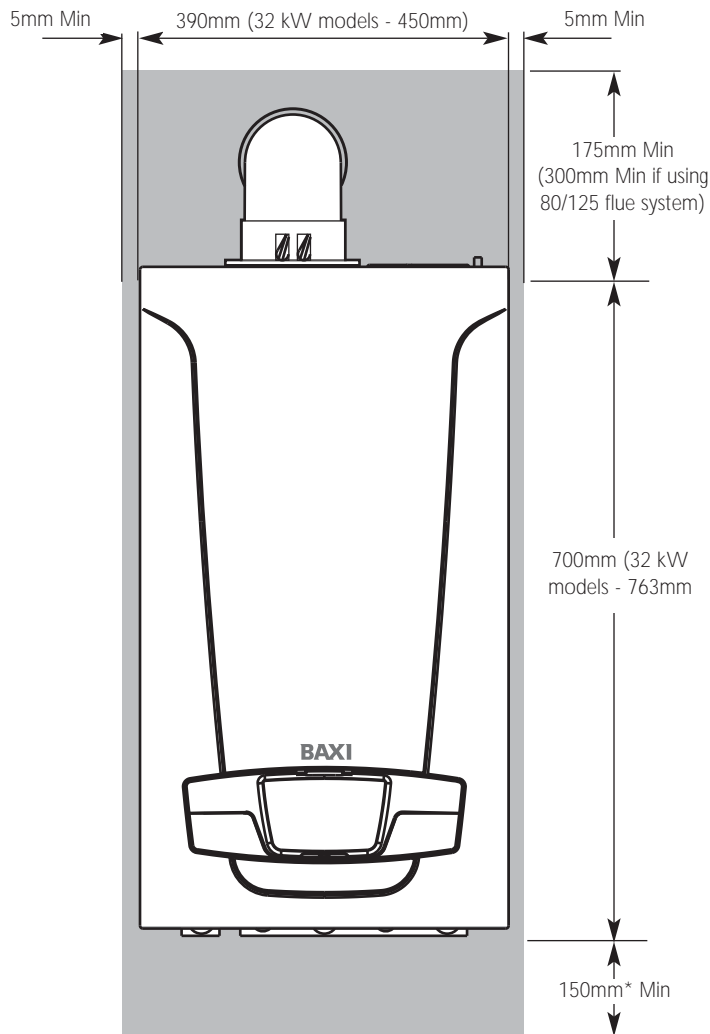

Fig. 3

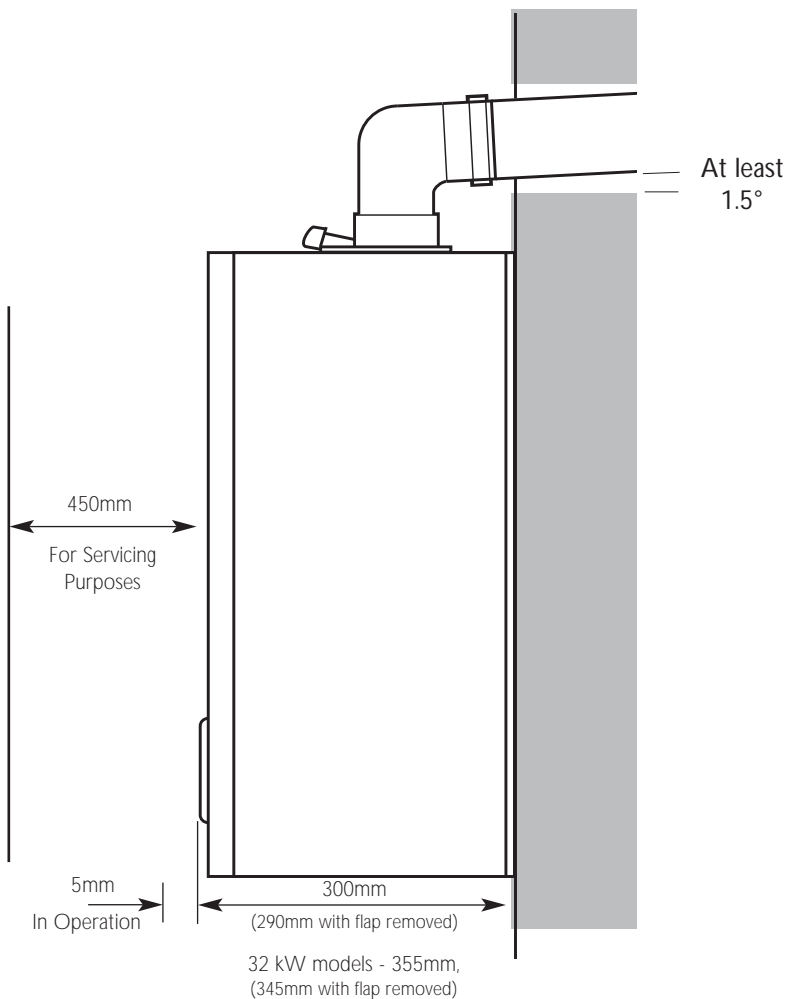

Fig. 4

## 5.0 Clearances

### 5.1 For your Safety

1. This appliance must have been installed in accordance with the manufacturer's instructions and the regulations in force.
2. Any modification that may interfere with the normal operation of the appliance without express written permission from the manufacturer or his agent could invalidate the appliance warranty. In GB this could also infringe the Gas Safety (Installation and Use) Regulations.

**GB** - Heating Industry definition meaning England, Scotland, Wales, Northern Ireland, Isle of Man and the Channel Isles.

3. Your boiler must not be operated without the casing correctly fitted.
4. Do not interfere with any sealed components on this boiler.
5. Take note of any warning labels on your boiler.
6. Your boiler should have the following minimum clearances for Safety and Maintenance (Figs. 3 & 4):-

Top	- 175mm
Bottom	- 150mm*
Left side	- 5mm
Right Side	- 5mm
Front	- 5mm (In Operation)
	- 450mm (For Servicing)

\*This is MINIMUM recommended dimension. Greater clearance will aid installation and maintenance.





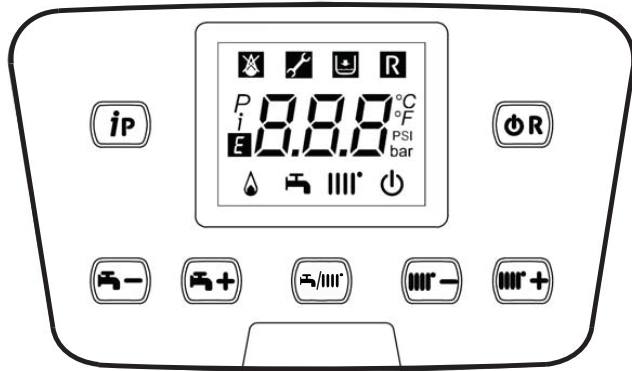

7. If your boiler is installed in a compartment, do not use it for storage purposes. Do not obstruct any purpose provided ventilation openings.
8. Flammable materials must not be stored in close proximity to your boiler.
9. Avoid skin contact when your boiler is in operation, as some surfaces may get hot e.g. pipework.
10. Ensure that the flue terminal, outside the house, does not become damaged or obstructed, particularly by foliage.
11. It is important that the condensate drain system is not blocked, modified or damaged in any way as this would affect the operation of your boiler. Your installer should have insulated any exposed pipework.



## 6.0 Error Codes























### 6.1 List of Error Codes

1. The display shows two types of signals:  and . In both cases the display shows  symbol and the numeric value of the error (see the “error table” below).
2.  The spanner cannot be reset by the user. Please contact your Installer, Annual Service Provider or ‘heateam’ - The Service Division of Baxi to arrange your Annual Service. You can contact ‘heateam’ on telephone number 08448 711 545 or visit [www.heateam.co.uk](http://www.heateam.co.uk)
3.  Fault errors can be resetting by pressing the  button.

**WARNING:** If an error code (is different from the ones described below) appears on the display or a certain fault appears frequently, contact ‘heateam’.

Table Of Error Codes

	09	Gas Valve Connection Cable
	15	Gas Valve Fault
	20	Central Heating NTC Fault
	28	Flue NTC Fault
	40	Central Heating Return NTC Fault
	55	Calibration Required
	109	Pre-circulation Fault
	110	Safety Thermostat Operated
	117	Primary System Water Pressure Too High
	118	Primary System Water Pressure Too Low
	125	Circulation Fault (Primary)
	128	Flame Failure
	130	Flue NTC Operated
	133	Interruption Of Gas Supply or Flame Failure
	134	Elapsed Time - Gas Valve Open Without Gas
	135	Interruption Of Gas Supply (Internal Error)
	154	Flow/Return Sensor Temperature Test
	160	Fan or Fan Wiring Fault
	270	Circulation Fault (Dry Fire)
	321	Hot Water NTC Fault
	384	False Flame

## 7.0 Legislation

### 7.1 Installation, Commissioning, Service & Repair

1. This appliance must be installed in accordance with the manufacturer's instructions and the regulations in force. Read the instructions fully before installing or using the appliance.
2. In GB, this must be carried out by a competent person as stated in the Gas Safety (Installation & Use) Regulations.
3. **Definition of competence:** A person who works for a Gas Safe registered company and holding current certificates in the relevant ACS modules, is deemed competent.
4. In IE (Eire), this must be carried out by a competent person as stated in I.S. 813 "Domestic Gas Installations".

**Lifting** - This product should be lifted and handled by two people. Stooping should be avoided and protective equipment worn where necessary. Carrying & lifting equipment should be used as required, e.g. when installing in a loft space.

---

All Gas Safe registered engineers carry an ID card with their licence number and a photograph. You can check your engineer is registered by telephoning 0800 408 5500 or online at [www.gassaferegister.co.uk](http://www.gassaferegister.co.uk)

---

The boiler meets the requirements of Statutory Instrument "The Boiler (Efficiency) Regulations 1993 No 3083" and is deemed to meet the requirements of Directive 92/42/EEC on the energy efficiency requirements for new hot water boilers fired with liquid or gaseous fuels:-

Type test for purpose of Regulation 5 certified by:  
Notified Body 0085.

Product/Production certified by:  
Notified Body 0086.  
Ref: 86-BL-647

For GB/IE only.

---

### 7.2 Benchmark Commissioning Checklist

1. Please ensure that the installer has fully completed the Benchmark Checklist on the inside back pages of the installation instructions supplied with the product and that you have signed it to say that you have received a full and clear explanation of its operation. The installer is legally required to complete a commissioning checklist as a means of complying with the appropriate Building Regulations (England and Wales).
  2. All installations must be notified to Local Area Building Control either directly or through a Competent Persons Control either directly or through a Competent Persons Scheme. A Building Regulations Compliance Certificate will then be issued to the customer who should, on receipt, write the Notification Number on the Benchmark Checklist.
  3. This product should be serviced regularly to optimise its safety, efficiency and performance. The service engineer should complete the relevant Service Record on the Benchmark Checklist after each service.
  4. The completed Benchmark Checklist may be required in the event of any warranty work.
-

### Warning !

#### If you smell gas

- Do not operate light switches
- Do not operate any electrical equipment
- Do not use a telephone in the hazardous area
- Extinguish any naked flame and do not smoke
- Open windows and doors in the hazardous area
- Turn off the gas supply at the meter
- Warn any other occupants and vacate the premises
- Telephone the National Gas Emergency Service on:-  
0800 111 999

#### Faulty boiler

If it is known or suspected that there is a fault on the boiler that cannot be manually reset, it must not be used until the fault has been corrected by a competent person.

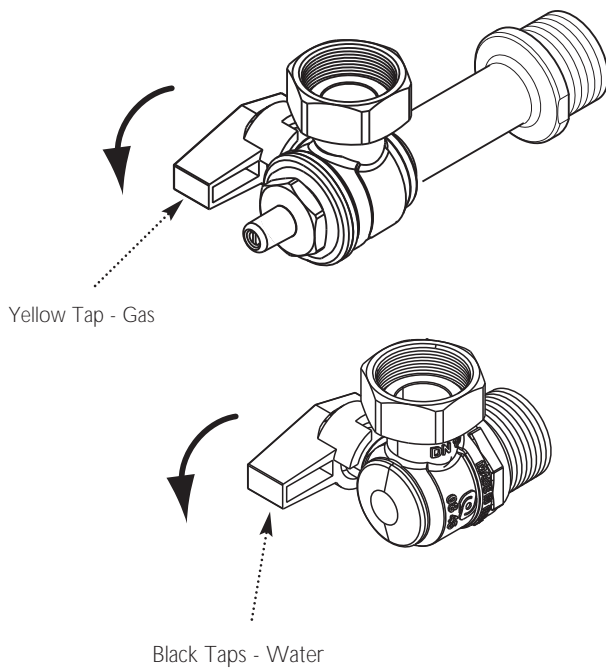

#### In an Emergency

1. If a water or gas leak occurs or is suspected, the boiler can be isolated at the inlet valves by turning their taps through 90° ( $\frac{1}{4}$  turn) downwards
2. Please contact your Installer, Annual Service Provider or 'heateam' - The Service Division of Baxi. You can contact 'heateam' on telephone number 0844 871 1525 or visit [www.heateam.co.uk](http://www.heateam.co.uk) as soon as possible.

Please complete the boxes below

Serial Number

Date of Installation

D	D	M	M	Y	Y

Installer Details (name, address and contact number(s))

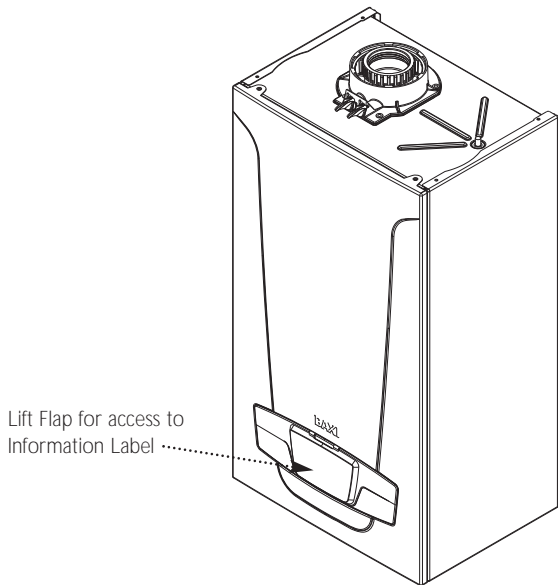

All descriptions and illustrations provided in this leaflet have been carefully prepared but we reserve the right to make changes and improvements in our products which may affect the accuracy of the information contained in this leaflet. All goods are sold subject to our standard Conditions of Sale which are available on request.

**BAXI**  
A Trading Division of Baxi Heating UK Ltd (3879156)  
Brooks House, Coventry Road, Warwick. CV34 4LL  
After Sales Service 0844 871 1525 Technical Enquiries 0844 871 1555  
Website [www.baxi.co.uk](http://www.baxi.co.uk)  
e&oe

PART OF BDR THERMEA

## 9.0 Warranty & Service

### Standard Warranty Terms & Conditions

To activate your second year free warranty you must register your boiler with **heateam** the service division of Baxi Heating UK Ltd either by completing and returning the registration card or calling our telephone registration line on **0800 013 7989**.

It is also a requirement of the warranty that the boiler has an annual service (every 12 months) in accordance with the installation and servicing instructions, performed by a Gas Safe registered engineer. If you would like **heateam** to carry this out please call on **0844 871 1525**.

### Our promise to you

If you experience a fault with your new boiler, we aim to provide a safe and high quality repair service supported by our dedicated national network of highly skilled engineers. If your installer can't resolve the problem for you, we will do everything we can to get an engineer out to you as quickly as possible. Nothing in this warranty will affect your statutory consumer rights.

### What you need to do if you experience a problem with your heating system or the operation of the boiler

You should always contact your installer first, because the cause of the fault may not be related to the boiler. If your installer confirms that the fault is with the boiler and he/she can't repair it, our friendly customer service team is on hand to help. Simply call our service division **heateam** on **0844 871 1525** to book an engineer visit or for any general advice that you may need. Our contact centre is open Monday to Friday 8am - 6pm, weekends and Bank Holidays 8.30am - 2pm, excluding Christmas Day and New Years Day.

When calling **heateam** it would be helpful if you could have the following information to hand:-

- 1 Boiler serial number (see opposite).
- 2 Boiler make and model number.
- 3 Your installer name and address details.
- 4 Proof of purchase (if you do not have the boiler serial number).

### What this warranty covers

Free of charge repair or replacement of components found to be of faulty manufacture.

Free of charge replacement of the complete unit provided always that the failure is related to a manufacturing fault that cannot be repaired or is uneconomic to repair.

### What this warranty does not cover

Repairs to boilers which haven't been installed and commissioned properly, and as set out in the installation instructions (this includes the need to flush the system effectively and add a suitable corrosion inhibitor).

Any damage caused by hard water scale deposits and/or aggressive water resulting from corrosion.

Any other defects or failures, either in the connected heating system or outside of the boiler itself.

Faults caused by inadequate supply of electricity, gas or water to the property.

Installations within commercial settings for which this boiler was not designed.

Reimbursement of any third party repair or replacement costs that we haven't been told about or agreed with you in advance.

Compensation for consequential losses (e.g. loss of earnings, business losses, stress and inconvenience) arising from a production breakdown, including repair delays caused by factors outside our reasonable control.

After Sales Service 0844 871 1525